



PCT

WORLD INTELLECTUAL PROPERTY ORGANIZATION
International Bureau

INTERNATIONAL APPLICATION PUBLISHED UNDER THE PATENT COOPERATION TREATY (PCT)

<p>(51) International Patent Classification 6: G09G 5/00, 5/36, H01J 13/00, G09B 17/00, 5/00</p>	<p>A1</p>	<p>(11) International Publication Number: WO 97/22108 (43) International Publication Date: 19 June 1997 (19.06.97)</p>
<p>(21) International Application Number: PCT/US96/20451 (22) International Filing Date: 13 December 1996 (13.12.96) (30) Priority Data: 08/572,406 14 December 1995 (14.12.95) US (71) Applicant: MOTOROLA INC. [US/US]; 1303 East Algonquin Road, Schaumburg, IL 60196 (US). (72) Inventors: HUFFMAN, James, R.; 4 Stegner Lane, Austin, TX 78746 (US). COLLINS, Russell, L.; 11705 Onion Hollow Run, Austin, TX 78739 (US). (74) Agents: INGRASSIA, Vincent, B. et al.; Motorola Inc., Intellectual Property Dept., P.O. Box 10219, Scottsdale, AZ 85271-0219 (US).</p>	<p>(81) Designated States: AM, AT, AU, BB, BG, BR, BY, CA, CH, CN, CU, CZ, DE, DK, EE, ES, FI, GB, GE, HU, IL, IS, JP, KE, KG, KP, KR, KZ, LK, LR, LT, LU, LV, MD, MG, MN, MW, MX, NO, NZ, PL, PT, RO, RU, SD, SE, SG, SI, SK, TJ, TM, TT, UA, UG, UZ, VN, European patent (AT, BE, CH, DE, DK, ES, FI, FR, GB, GR, IE, IT, LU, MC, NL, PT, SE). Published <i>With international search report. Before the expiration of the time limit for amending the claims and to be republished in the event of the receipt of amendments.</i></p>	

BEST AVAILABLE COPY

(54) Title: ELECTRONIC BOOK AND GRAPHICAL USER INTERFACE FOR SELECTING A BOOK TO READ THEREWITH

(57) Abstract

A method of selecting a book for reading in an electronic book includes displaying a first graphical book representation (200) and a second graphical book representation (204). A title (210) of a first book of a plurality of books is displayed on the second graphical book representation (204). In response to receiving a first user-initiated event in which a portion of the first graphical book representation (200) is selected, a title of a second book of the plurality of books is displayed in place of the title (210) of the first book. In response to receiving a second user-initiated event in which a portion of the second graphical book representation (204) is selected, machine-readable data is read from a machine-readable storage medium (136) installed in the electronic book. The text from the second book, which is represented by machine-readable data, is displayed.

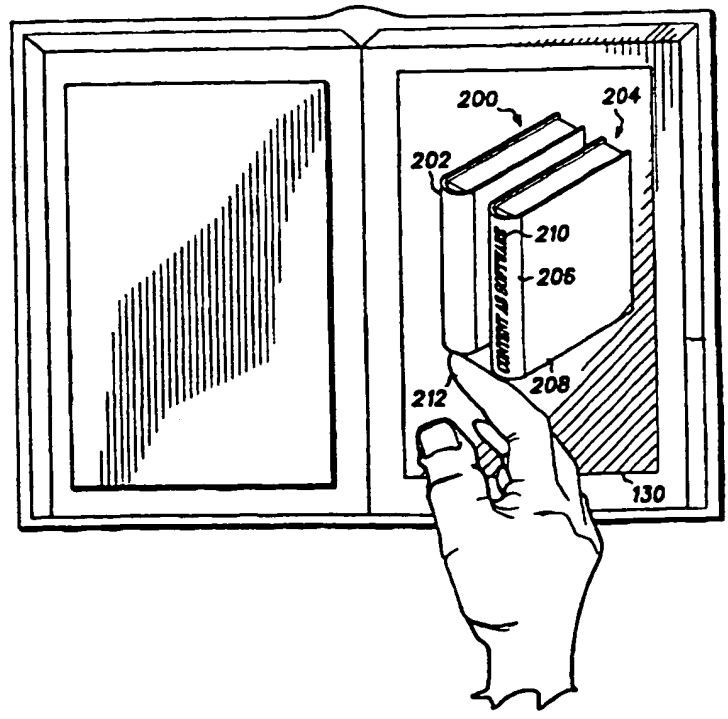

FOR THE PURPOSES OF INFORMATION ONLY

Codes used to identify States party to the PCT on the front pages of pamphlets publishing international applications under the PCT.

AM	Armenia	GB	United Kingdom	MW	Malawi
AT	Austria	GE	Georgia	MX	Mexico
AU	Australia	GN	Guinea	NE	Niger
BB	Barbados	GR	Greece	NL	Netherlands
BE	Belgium	HU	Hungary	NO	Norway
BF	Burkina Faso	IE	Ireland	NZ	New Zealand
BG	Bulgaria	IT	Italy	PL	Poland
BJ	Benin	JP	Japan	PT	Portugal
BR	Brazil	KE	Kenya	RO	Romania
BY	Belarus	KG	Kyrgyzstan	RU	Russian Federation
CA	Canada	KP	Democratic People's Republic of Korea	SD	Sudan
CF	Central African Republic	KR	Republic of Korea	SE	Sweden
CG	Congo	KZ	Kazakhstan	SG	Singapore
CH	Switzerland	LI	Liechtenstein	SI	Slovenia
CI	Côte d'Ivoire	LK	Sri Lanka	SK	Slovakia
CM	Cameroon	LR	Liberia	SN	Senegal
CN	China	LT	Lithuania	SZ	Swaziland
CS	Czechoslovakia	LU	Luxembourg	TD	Chad
CZ	Czech Republic	LV	Latvia	TG	Togo
DE	Germany	MC	Monaco	TJ	Tajikistan
DK	Denmark	MD	Republic of Moldova	TT	Trinidad and Tobago
EE	Estonia	MG	Madagascar	UA	Ukraine
ES	Spain	ML	Mali	UG	Uganda
FI	Finland	MN	Mongolia	US	United States of America
FR	France	MR	Mauritania	UZ	Uzbekistan
GA	Gabon			VN	Viet Nam

0 Serial No. 08/572,367, filed December 14, 1995.

"Electronic Book and a Method of Displaying a Relative Position of a Current Page of a Book Therefor", having Serial No. 08/572,373, filed December 14, 1995.

5 "Method and System for Encoding a Book for Reading Using an Electronic Book", having Serial No. 08/572,468, filed December 14, 1995.

"Electronic Book and Method of Displaying an Animated Page Turn Therefor", having Serial No. 08/572,405, filed December 14, 1995.

10 "Electronic Book and Method of Controlling a Rate of Information Displayed Thereby", having Serial No. 08/572,372, filed December 14, 1995.

"Reusable Housing and Memory Card Therefor", having Serial No. 08/572,413, filed December 14, 1995.

15 "Electronic Book and Method of Displaying at Least One Reading Metric Therefor", having Serial No. 08/572,842, filed December 14, 1995.

"Electronic Book and Method of Creating a Personal Log of Reading Activity Therefor", having Serial No. 08/572,456, filed December 14, 1995.

20 "Electronic Book Having Highlighting Feature", having Serial No. 08/572,469, filed December 14, 1995.

"Electronic Book and Method of Capturing and Storing a Quote Therein", having Serial No. 08/572,601, filed December 14, 1995.

25 The subject matter of the above-identified related inventions are hereby incorporated by reference into the disclosure of this invention.

Field of the Invention

30 The present invention relates to electronic books having the look and feel of real paper books and methods of selecting a book from a plurality of books for reading therewith.

Background of the Invention

35

Various types of hand-held electronic reading devices have been proposed to electronically display textual information for reading by a

0 user. A typical hand-held electronic reading device includes a display
device to display the textual information and a user interface which
allows a user to navigate through the textual information and access
various features of the electronic reading device. The display device
and the user interface are incorporated in a hand-held housing to
5 facilitate portability of the electronic reading device.

Many hand-held electronic reading devices have a user interface
in the form one or more external buttons. The buttons are depressed
in a predetermined manner either to navigate through the textual
information or to access various features of the device. However, many
10 hand-held electronic reading devices implement the user interface in a
manner which does not provide a simple, intuitive, or efficient method
for navigating the textual information or for accessing the features.

The lack of simplicity of using current hand-held electronic
reading devices along with the lack of comfort in handling many of
15 these devices result in some people preferring to read a real paper
book rather than using a hand-held electronic reading device.

Brief Description of the Drawings

20 The invention is pointed out with particularity in the appended
claims. However, other features of the invention will become more
apparent and the invention will be best understood by referring to the
following detailed description in conjunction with the accompanying
drawings in which:

25 FIG. 1 is a view of an embodiment of an electronic book in a
closed position;

FIG. 2 is a view of the embodiment of the electronic book of FIG.
1 in an open position;

30 FIG. 3 is a block diagram of an embodiment of the electronic
book;

FIG. 4 is an illustration of various hot spot locations used to
provide control of the electronic book to a user;

FIG. 5 is an illustration of a library screen display using an
embodiment of the electronic book;

35 FIG. 6 is an illustration of a user-initiated event to open the
desired book from the library screen;

FIG. 7 is an illustration of a first page of a book displayed on an

0 embodiment of the electronic book;

FIG. 8 is an illustration of a title page of a book displayed on an embodiment of the electronic book;

FIG. 9 is an illustration of a font selection page displayed on an embodiment of the electronic book;

5 FIG. 10 is an illustration of the title page of the book which is displayed upon exiting the font selection page;

FIG. 11 is an illustration of a system control page displayed in an embodiment of the electronic book;

10 FIG. 12 is an illustration of the title page of the book which is displayed upon exiting the system control page;

FIG. 13 is an illustration of the title page of the book wherein a radio frequency link option is selected;

FIG. 14 is an illustration of the title page of the book wherein a pacing control option is selected by a user;

15 FIG. 15 is an illustration of a pacing control page displayed in an embodiment of the electronic book;

FIG. 16 is an illustration of the title page of the book which depicts other user-initiated options;

20 FIG. 17 is an illustration of a page marked by a dog ear for use in embodiments of the electronic book;

FIG. 18 is an illustration of a dog ear dialog box used in embodiments of the electronic book;

FIG. 19 is an illustration of a user selecting a portion of a page of text;

25 FIG. 20 is an illustration of an option selection dialog box used in embodiments of the electronic book;

FIG. 21 is an illustration of an annotation display used in embodiments of the electronic book;

30 FIG. 22 is an illustration of a marker used to indicate that a page has an annotation associated therewith;

FIG. 23 is an illustration of a user selecting a set bookmark option in the option selection dialog box;

FIG. 24 is an illustration of the page of FIG. 23 having a bookmark displayed thereon;

35 FIG. 25 is a flow diagram of an event loop performed in an embodiment of the electronic book;

FIG. 26 is a flow diagram of steps performed in an embodiment of

0 a library graphical user interface routine for use in the electronic book;
FIGS. 27 and 28 show flow diagrams of an embodiment of the
routine to display pages of text in the electronic book;

FIG. 29 is a flow diagram of steps performed to display a current
page in the electronic book;

5 FIG. 30 is a flow diagram of steps performed in an embodiment of
an annotation subroutine;

FIG. 31 is a flow diagram of steps performed in an embodiment of
a quote capture subroutine;

10 FIG. 32 is a flow diagram of steps performed in an embodiment of
a dog ear subroutine;

FIG. 33 is a flow diagram of steps performed in an embodiment of
a pacing control subroutine;

FIG. 34 is a flow diagram of steps performed in an embodiment of
the font selection subroutine; and

15 FIG. 35 is a flow diagram of steps performed in an embodiment of
the system control subroutine.

Detailed Description of a Preferred Embodiment

20 Embodiments of the present invention advantageously provide an
electronic book with an improved graphical user interface for selecting
a book for reading from a plurality of books. In an illustrated
embodiment, the graphical user interface utilizes two graphical book
representations for receiving user-initiated events or actions to scroll
25 through the plurality of books and to open a desired one of the
plurality of books.

FIG. 1 is a view of an embodiment of an electronic book in a
closed position. The electronic book has a book-shaped housing 100
having the look and feel of a real, paper book. The book-shaped
30 housing 100 has a first housing member 102 pivotably connected to a
second housing member 104 to facilitate opening and closing in a book-
like manner. The first housing member is partially formed by a book-
like, front cover member 106. In a similar manner, the second housing
member 104 is partially formed by a book-like, back cover member
35 108. The front cover member 106 and the back cover member 108 are
pivotably connected by a spine member 110.

To better provide the look and feel of a real book, the front cover

0 member 106 and the back cover member 108 have an exterior made of
a material used in real book covers. Examples of such a material
include, but are not limited to, leather, simulated leather, vinyl, and a
woven fabric such as cotton. The exterior can either be permanently
5 108, or be in the form of a removable jacket.

In addition to the front cover member 106, the first housing
member 102 is partially defined by an enclosure 112. Similarly, the
second housing member 104 is partially defined by an enclosure 114 in
10 addition to the back cover member 108. When the electronic book is in
the closed position, the enclosure 112 and the enclosure 114 have an
external appearance of edges of pages of a real, paper book. In
particular, the enclosures 112 and 114 define a top edge 116, a bottom
edge 118, and a foreedge 120 which appear as the top edge, the bottom
edge, and the foreedge, respectively, of a real, paper book. The top edge
15 116, the bottom edge 118, and the foreedge 120 are recessed with
respect to the front cover member 106 and the back cover member
108.

FIG. 2 is a view of the embodiment of the electronic book of FIG.
1 in an open position. It is preferred that the first housing member
20 102 and the second housing member 104 be substantially symmetric
so that the front cover member 106, the back cover member 108, and
the spine member 110 rest substantially flat on a flat surface in the
open position. The substantial symmetry makes the electronic book
feel like a real, paper book being opened to one of its middle pages. As
25 a result, the electronic book can be comfortably held and read in a
manner consistent with a paper book.

A touchscreen 130 is integrated in the book-shaped housing 100
to be accessible when the book-shaped housing 100 is opened in the
book-like manner. In the embodiment illustrated in FIG. 2, the
30 touchscreen 130 is integrated with the enclosure 114 of the second
housing member 104. Optionally, a second touchscreen 132 can also be
integrated in the book-shaped housing. As illustrated, the second
touchscreen 132 can be integrated with the enclosure 112 of the first
housing member 102.

35 The touchscreen 130 and the second touchscreen 132 each
include a touch-sensitive panel over a display device. Behind the
display device can be a backlighting element.

0 The touchscreen 130 and the second touchscreen 132 may
provide either a color display or a monochrome display depending on a
particular model of the electronic book. To provide their touch
sensitivity, the touchscreen 130 and the second touchscreen 132 can
utilize analog resistive technology as is known in the art. It is noted,
5 however, that other technologies for providing touch sensitivity can
also be utilized.

 It is preferred that the touchscreen 130 and the second
touchscreen 132 be capable of providing backlighting to allow use of
the electronic book in poorly-lit or dimly-lit environments. More
10 preferably, the touchscreen 130 is capable of backlighting selected
portions or subsets of the entire touchscreen 130. Here, the electronic
book can provide a power-saving mode wherein only a portion of the
touchscreen 130 being viewed by a user is actively backlit.

 The book-shaped housing includes a receiving slot 134 which
15 physically receives a removable machine-readable storage medium
136. The removable machine-readable storage medium 136 contains
machine-readable data representative of text from a book. Optionally,
the machine-readable data is also representative of graphical
information within the book. It is noted that the term "book" should be
20 construed broadly as any written or printed composition having textual
information which is read by an individual. Hence, the term "book"
should be inclusive of books, magazines, newspapers, or the like.

 The text and the graphical information contained in the
removable machine-readable storage medium 136 are displayed on the
25 touchscreen 130. The second touchscreen 132 can be included to
display graphical information while the touchscreen 130 displays text.
As another option, the touchscreen 130 and the second touchscreen
132 can display neighboring pages of the book. Further, the
touchscreen 130 and the second touchscreen 132 can be utilized to
30 simultaneously view two books. The second touchscreen 132 can also
be utilized in a second level operating system, which is herein called an
advanced reader graphical user interface. The functionality of the
second touchscreen 132 can be selected by the user using a switch or
the advanced reader graphical user interface in the electronic book.

35 It is noted that there are a number of ways to encode the text
and the graphical information within the book for storage on the
removable machine-readable storage medium 136. In one

0 embodiment, the removable machine-readable storage medium 136
contains a series of pointers which point to words contained in a
dictionary within the electronic book. Words which are not contained
in the dictionary are located in a customized dictionary on the
removable machine-readable storage medium 136. In this way, the
5 words to be presented on the touchscreen 130 are selected with
minimal storage requirements in the removable machine-readable
storage medium 136.

Preferably, the removable machine-readable storage medium 136
is in the form of either a smart card or a PCMCIA card. Here, the
10 receiving slot 134 is shaped to receive either a smart card or a PCMCIA
card.

The book-shaped housing 100 further defines a power-receiving
port 138 and a data-receiving port 140. The power-receiving port 138
receives a plug or other type of connector to supply power to the
15 electronic book. Power supplied to the electronic book via the power
receiving port 138 can be used to directly operate the electronic book
or to recharge batteries internal to the electronic book. In one
embodiment of the electronic book, the spine member 110 is shaped to
receive a combination of battery cells which can be recharged via the
20 power-receiving port 138. If the second touchscreen 132 is not used,
the enclosure 112 of the first housing member 102 can be used to store
extra batteries and/or extra book cards.

The data port 140 is utilized to communicate signals
representative of machine-readable data between the electronic book
25 and an external device. The data port 140 can be used, for example, to
receive machine-readable data signals representative of text and
graphics in a book from the external device for storage in the electronic
book. In this manner, the data port 140 provides an alternative to the
receiving slot 134 for receiving text and graphics of a book.

30 Additionally, the data port 140 can be utilized to transmit machine-
readable data contained within the electronic book to the external
device.

Preferably, the electronic book is automatically activated (i.e.,
automatically turns on) when in the open position, and is automatically
35 deactivated (i.e. automatically turns off) when in the closed position.
To this end, the electronic book can include a magnet 142 incorporated
within one of the first housing member 102 or the second housing

0 member, and a reed switch 144 incorporated within the other housing
member. When the electronic book is in the closed position, the
magnet 142 is proximate to the reed switch 144. The magnetic field
generated by the magnet 142 causes the reed switch 144 to assume a
5 first switch position which deactivates the electronic book. When the
electronic book is in the open position, the magnet 142 is distant from
the reed switch 144. In absence of a significant magnetic field, the
reed switch 144 returns to a second switch position which activates the
electronic book.

10 It is noted that in alternative embodiments, the electronic book is
activated and deactivated by an external switch or button (not
specifically illustrated) rather than by the reed switch 144.

15 FIG. 3 is a block diagram of an embodiment of the electronic
book. An interface 150 receives the removable machine-readable
storage medium 136 containing machine-readable data representative
of text and graphics from a book. In a preferred embodiment of the
present invention, the interface 150 comprises a PCMCIA interface
which receives a removable machine-readable storage medium in the
form of a PCMCIA card. Physically, the interface 150 is proximate to
the receiving slot 134 illustrated in FIG. 2.

20 In general, it is preferred that the interface 150 be capable of
receiving an external device other than a machine-readable storage
medium. Further, it is preferred that the interface 150 be capable of
receiving a plurality of external devices. To these ends, the interface
150 can comprise a plurality of similar interfaces, such as a plurality of
25 PCMCIA interfaces. Here, the electronic book can simultaneously
receive two or more of a PCMCIA memory card, a PCMCIA modem, or
another PCMCIA device.

30 A processor 152 is in communication with the interface 150 to
read the machine-readable data from the removable machine-readable
storage medium 136. The processor 152 can be in the form of a
microprocessor, a custom integrated circuit, an application specific
integrated circuit, or a programmable logic array, for example.
Physically, the processor 152 is housed within the book-shaped housing
100.

35 The touchscreen 130 is in communication with the processor 152
to display a page of the text and/or the graphics represented by the
machine-readable data. Further, the touchscreen 130 acts as an input

applied 0. device to receive user-initiated events, i.e. user-initiated actions, and
(such as 1. communicate these user-initiated events or actions to the processor
trackball) 152.

5 An internal machine-readable storage medium 154 is in
communication with the processor 152 to support a number of
operative features of the electronic book. The internal machine-
readable storage medium 154 can include one or more memory
devices, such as a random access memory, a read-only memory, and/or
an electronically erasable and programmable read-only memory
(EEPROM).

10 A computer program or other form of software or firmware is
stored in the internal machine-readable storage medium 154. The
computer program directs the processor 152 to support the operative
features of the electronic book. Preferably, the computer program
includes an event loop that processes and responds to user-initiated
15 events and actions. More specifically, received events are placed in an
event queue in the internal machine-readable storage medium 154.
Each of the received events is processed and removed from the event
queue. As a result, a user can initiate a number of events or actions
without having to wait for previous actions to be processed.

20 The internal machine-readable storage medium 154 can also
include a dictionary to which pointers stored in the removable
machine-readable storage medium 136 point. By including the
dictionary within the electronic book, less storage space is required on
the removable machine-readable storage medium 136 to store the text
25 from the book.

Further, the internal machine-readable storage medium 154 can
contain machine-readable data representative of text and graphics
from a book. Here, the processor 152 reads the machine-readable data
from the internal machine-readable storage medium 154 and
30 commands the touchscreen 130 to display pages of the text and
graphics.

Signals are communicated between the electronic book and an
external device via either a data interface 156 in communication with
the processor 152, via an antenna 158 and a radio frequency modem
35 160 in communication with the processor 152, or via an infrared
transceiver 161 in communication with the processor. As another
option, communication between the electronic book and the external

0 device can be effectuated using either a smart communication card or a
PCMCIA communication card received by the interface 150. Here, a
PCMCIA modem card or a PCMCIA infrared transceiver card can be
utilized, for example, for external communication.

Optionally, a voice synthesizer 162 is included in the electronic
5 book to provide a spoken auditory display of pages of the text read
from either the removable machine-readable storage medium 136 or
the internal machine-readable storage medium 154. In one
embodiment, the processor 152 directly converts the text from the
book into speech signals for the voice synthesizer 162. Optionally,
10 control codes can be provided within the removable machine-readable
storage medium 136 to allow words to be pronounced or emphasized in
different ways. Further, the control codes can command the words to
be spoken in either a male voice, a female voice, or a child's voice. The
synthesized voice can be sampled (such as using the user's voice) or
15 can be a computer-synthesized voice.

As an alternative, a custom voice dictionary can be provided to
augment a general voice dictionary stored in the electronic book. The
customized voice dictionary can be used for alternative pronunciations,
voices, and emphasis.

20 The voice synthesizer 162 is either permanently integrated in the
electronic book or is a removable accessory. To facilitate removability,
the voice synthesizer 162 can be embodied within a smart card or a
PCMCIA card for reception by the interface 150. Alternatively, the
voice synthesizer 162 can communicate with the processor 152 via an
25 accessory interface bus 163. In a similar manner, the RF modem 160
and/or the second touchscreen 132 can communicate with the
processor 152 via the accessory interface bus 163.

Before giving a detailed description of steps performed by the
elements of FIG. 3 for the various embodiments of the present
30 invention, a functional description of a particular embodiment of the
electronic book will now be described. This embodiment is based on a
single touchscreen, namely the touchscreen 130, to display the text and
the graphics of the book and to allow a user to control the electronic
book. It is noted, however, that the teachings herein can also be
35 applied to a dual touchscreen embodiment which further includes the
second touchscreen 132. Furthermore, it is noted that the teachings
herein are not limited to the use of a touchscreen, and hence, can be

0 applied to an electronic book containing any type of display device
(such as a liquid crystal display or a cathode ray tube, for example) and
any type of input device (such as a series of buttons, a mouse, a
trackball, a lightpen, or a touchpad, for example).

FIG. 4 is an illustration of various hot spot locations used to
5 provide control of the electronic book to a user. A page of the text
represented by the machine-readable data read from either the
removable machine-readable storage medium 136 or the internal
machine-readable storage medium 154 is displayed on a display
portion 168 of the touchscreen 130. The display portion 168 is also
10 utilized to display graphics represented by the machine-readable data.

A first hot spot portion 170 of the touchscreen 130 is designated
for receiving a predetermined user-initiated event which requests that
a subsequent page of the text be displayed on the touchscreen 130.
Hence, the first hot spot portion 170 can be synonymously referred to
15 as an "advance page portion" or an "advance page hot spot" for
receiving an advance page event. In the embodiment illustrated in FIG.
4, the first hot spot portion 170 includes a top margin portion 172, a
side margin portion 174, and a bottom margin portion 176 of the
touchscreen 130. The top margin portion 172 is located above the
20 display portion 168, the side margin portion 174 is located beside the
display portion 168, and the bottom margin portion 176 is located
below the display portion 168.

A second hot spot portion 178 of the touchscreen 130 is
designated for receiving a predetermined user-initiated event which
25 requests that a previous page of the text be displayed. Hence, the
second hot spot portion 178 can be synonymously referred to as a
"page back portion" or a "page back hot spot" for receiving a page back
event. In the embodiment illustrated in FIG. 4, the second hot spot
portion 178 is located beside the display portion 168 of the
30 touchscreen 130 and opposite the side margin portion 174.

A third hot spot portion 180 of the touchscreen 130 is designated
for receiving a predetermined user-initiated event which requests that
a pre-marked page be displayed on the touchscreen 130. In the
embodiment of FIG. 4, the third hot spot portion 180 is located in an
35 upper portion of the touchscreen 130 and is shaped as a bookmark
graphic 182. Hence, the third hot spot portion 180 can be
synonymously referred to as a "bookmark portion" or a "bookmark hot

0 spot".

A fourth hot spot portion 184 of the touchscreen 130 is designated for receiving a predetermined user-initiated event to close the current book being read and to request that a library screen be displayed on the touchscreen 130. The library screen is utilized by a user to select a book to read from a plurality of books within a library. Hence, the fourth hot spot portion 184 can be synonymously referred to as a "close book portion" or a "close book hot spot" for receiving a close book event.

A fifth hot spot portion 186 of the touchscreen 130 is designated for receiving a predetermined user-initiated event which requests that the displayed page be marked. In the embodiment of FIG. 4, the fifth hot spot portion 186 is located in an upper corner of the touchscreen 130. In this embodiment, the fifth hot spot portion 186 of the touchscreen 130 is utilized for dog-earring pages of the book. Hence, the fifth hot spot portion 186 can be synonymously referred to as a "dog ear portion" or a "dog ear hot spot" for receiving a dog ear event.

A sixth portion 188 of the touchscreen 130 is designated to provide a depth indication representative of how much of the book is left to be read. In the embodiment illustrated in FIG. 4, the sixth portion 188 is located above the display portion 168. The second hot spot portion 178 can be utilized in conjunction with the sixth portion 188 to provide the depth indication.

In the embodiment of FIG. 4, the display portion 168, the first hot spot portion 170, the second hot spot portion 178, the third hot spot portion 180, the fourth hot spot portion 184, and the fifth hot spot portion 186 are mutually exclusive (i.e. non-overlapping) portions of the touchscreen 130. However, in alternative embodiments of the present invention, these portions may not be mutually exclusive, and hence may overlap. Further, some embodiments of the present invention may utilize different sizes and positions for the above-described hot spot portions.

Preferably, the hot spot portions are motion sensitive so that a touch event, a touch-and-hold event, and a drag event can be sensed to initiate differing responses. For example, a page back event can be received in the form of a flipping motion (i.e. a short stroke) across the second hot spot portion 178.

FIG. 5 is an illustration of a library screen displayed using an

0 embodiment of the electronic book. In a preferred embodiment, the
library screen is displayed upon opening the electronic book or
activating the electronic book. The library screen includes a rearward
graphical book representation 200 having a graphical spine portion
202. A forward graphical book representation 204 is displayed in front
5 of the rearward graphical book representation 200. The forward
graphical book representation 204 has a graphical spine portion 206
and a graphical front cover portion 208. A title 210 of a book currently
being read is displayed on the forward graphical book representation
204. In the embodiment illustrated in FIG. 5, the title 210 is displayed
10 on the graphical spine portion 206 of the forward graphical book
representation 204.

Upon receiving a user-initiated event in which a portion of the
rearward graphical book representation 200 is selected, a title of
another book or books of a plurality of books in a library is displayed
15 in place of the title 210 on the forward graphical book representation
204. In a preferred embodiment, the portion of the rearward graphical
book representation 200 selected in this user-initiated event is within
the graphical spine portion 202.

The titles of the books in the library can be obtained from a
20 storage medium (which contains the books) installed in the electronic
book. Alternatively, the titles of the books can be obtained by a
connection to an information service providing books or other
information in real time. As another alternative, the titles and the
books can be accessed on demand from a world-wide web page.

25 A user can scroll through the library of books by repeatedly
touching the spine portion 202 with his or her finger 212 until a
desired book title is pulled into view. When the spine portion 202 is
selected for a last of the plurality of books, the title of the first book is
displayed. In this manner, the user can rotate through the library of
30 books until a desired book is in front.

FIG. 6 is an illustration of a user-initiated event to open the
desired book from the library screen. The forward book is opened
upon receiving a user-initiated event in which a portion of the forward
graphical book representation 204 is selected. This user-initiated event
35 can include, for example, the user touching the front cover portion 208
of the forward graphical book representation 204 using his or her
finger 212. In response to this user-initiated event, the book indicated

0 by a title 214 is opened. If the book is previously unread, the book is
opened to page one. If the book has been read before, the book opens
to a page which was last read.

FIG. 7 is an illustration of a first page of a book displayed on the
touchscreen 130 upon exiting the library screen. To display the first
5 page of the book, the machine-readable data representative of text and
graphics from the book is read from either the removable machine-
readable storage medium 136 installed in the electronic book, or from
the internal machine-readable storage medium 154. Upon reading the
machine-readable data, a page of the text and/or the graphics is then
10 displayed on the touchscreen 130. As shown, the text is displayed to
appear as a standard page in a real book.

If a user-initiated event is received in which a user selects the
second hot spot portion 178, i.e. the page back portion, of the
touchscreen 130 when the book is on the first page, then a title page
15 containing system controls is displayed.

FIG. 8 is an illustration of a title page of a book displayed on an
embodiment of the electronic book. Information which is displayed on
the title page includes a book title 220, author information 222,
copyright information 224, a Library of Congress number 226, and
20 publisher information 228. Also displayed are statistics such as a total
number of pages 230 in the book, a number of pages left to be read
232, and an elapsed reading time 234.

A number of control options are also displayed. These control
options include, but are not limited to, a pacing control option 236, a
25 font selection option 238, a system control option 240, a read-to-me
option 242, and a radio frequency (RF) link option 244. Any of these
control options can be initiated by a respective user-initiated event
indicative of a user selecting the option. As illustrated in FIG. 8, a user
is initiating a font selection routine by touching the font selection
30 option 238 using his or her finger 212.

FIG. 9 is an illustration of a font selection page displayed on an
embodiment of the electronic book. The font selection page is
displayed upon an initiation of the font selection routine.

Displayed on the font selection page are a number of font/size
35 combination options. Each option is in the form of a word displayed
using a specific font and a specific size in accordance with the font/size
combination. A user selects a desired font/size combination by viewing

0 how words appear in the various combinations, and selecting the combination which is desired. For example, in FIG. 9, the user is selecting a desired font/size combination by selecting a word 250 displayed in the desired font/size combination using his or her finger 212.

5 The fonts can be selected from internal fonts and custom fonts provided on the medium provided by a publisher. For example, a user may select a Gothic font provided on a medium containing a Shakespeare work instead of default fonts (e.g. Courier, Helvetica, Avant Garde) within the electronic book.

10 Upon selecting the desired font/size combination, the electronic book automatically flips back to the title page containing the system controls. Thereafter, the electronic book uses the desired font/size combination as a primary font/size combination to display the text of the book. Titles and headings in the book are enlarged and bolded
15 based upon the primary font/size combination. Other portions of text can be italicized based on the primary font. However, it is preferred that the body of the text never be displayed smaller than the size selected in the primary font/size combination. In some embodiments, it may be preferred to display footnotes in a size smaller than the size
20 selected.

FIG. 10 is an illustration of the title page of the book which is displayed upon exiting the font selection page. Here, a user is shown to initiate a system control routine by selecting the system controls option 240 using his or her finger 212.

25 FIG. 11 is an illustration of a system control page displayed in an embodiment of the electronic book. The system control page is displayed upon executing the system control routine.

The system control page provides a number of display controls including a contrast control 254, a tint control 256, and a color control
30 258. Each of these controls provides a discrete number of control values which can be directly selected by a user. Further, each control value is displayed in a graphical manner consistent with the result of its selection. For example, the contrast control 254 includes a high contrast graphical representation 262, an intermediate contrast
35 graphical representation 264, and a low contrast graphical representation 266. The graphical representations 262, 264, and 266 are of the same graphical image, but are displayed using different

0 contrast control values. Hence, a user can visually determine a desired
contrast by viewing the graphical representations 262, 264 and 266.
In a similar manner, the tint control 256 and the color control 258 each
display a predetermined graphical image using a discrete number of
tint control values and color control values, respectively.

5 Preferably, the display of the graphical representations within
the display controls are unaffected by current values of selected ones
of the controls. In one preferred embodiment, the display of the
graphical representations is independent of all of the current values.
For example, the display of the low contrast representation 266 can be
10 independent of the current contrast control value, the current tint
control value, and the current color control value. In another preferred
embodiment, the display of the graphical representations in each
control is independent of the current value of that control, but depend
on the current value of the other controls. Here, for example, the
15 display of the low contrast representation 266 is independent of the
current contrast control value, but dependent upon the current tint
control value and the current color control value. Using either of these
two embodiments, a user can immediately determine a result of each
control value selection before actually performing the selection.

20 The system control page also includes a sound control 267. The
sound control 267 is illustrated to have a discrete number of sound
intensity values which can be selected by a user. In the embodiment
of FIG. 11, the sound intensity values are monotonically related to the
size of an ear displayed on the sound control 267. An ear 268 having a
25 slash therethrough is indicative of an option to turn off the sound. For
the purpose of illustration, FIG. 11 shows a user selecting an
intermediate sound intensity by touching an ear graphic 269. The user
then returns to the system control page by touching the second hot
spot portion 178, i.e. the page back hot spot, of the touchscreen 130. -

30 It is noted that the controls on the system control page can
provide continuous, rather than discrete, control of the control values
in alternative embodiments of the electronic book. Here, for example,
the ear size and the volume can increase or decrease based on finger
selection movement.

35 A pad area 270 of the system control page is utilized for testing
motions such as a hold event, a turn event, and a mark event. In
particular, a user can point to any of a hold selection 271, a turn

0 selection 272, and a mark selection 273, and then perform the selected
motion in the pad area 270. Here, a length of hold time or style of
dragging a finger for a flip command can be gauged for each user, for
example, using the pad area 270.

5 FIG. 12 is an illustration of the title page of the book which is
displayed upon exiting the system control page. Here, the user is
illustrated to select the read-to-me option 244 which initiates the voice
synthesizer 162 to audibly read the text being visually displayed on
the touchscreen 130. The audible reading of the text begins at the last
10 and other controls for the read-to-me routine is provided on a pacing
control page described hereinafter.

15 FIG. 13 is an illustration of the title page of the book wherein a
radio frequency link option is selected. This option is selected by the
user by touching the RF link option 244 using his or her finger 212.
Upon selecting the RF link option 244, an RF link routine is executed.
The RF link routine allows the user to download updates of the text to
the electronic book, and/or to interface the electronic book to a
personal computer or communication unit. The RF link routine utilizes
20 the antenna 158 and the RF modem 160 illustrated in FIG. 3 to
communicate with the personal computer using a local wireless link, or
more generally to communicate with a wireless data communication
network. Utilizing a nationwide wireless data communication network,
such as the Ardis network, allows individuals to receive book updates
via radio frequency links in major cities.

25 FIG. 14 is an illustration of the title page of the book wherein a
pacing control option is selected by a user. Specifically, the user is
shown to initiate a pacing control routine by selecting the pacing
control option 236 displayed on the title page using his or her finger
212.

30 FIG. 15 is an illustration of a pacing control page displayed in an
embodiment of the electronic book. The pacing control page is
displayed once the user selects the pacing control option 236 from the
title page. The pacing control page includes a display 280 of a current
reading pace of the user. Based upon the number of pages left in the
35 book, which is given in a display 282, a display 284 of an estimated
completion time for the book is also given. In the embodiment of FIG.
15, the current reading pace, the number of pages left, and the

on 500 estimated completion time are displayed in the form of one or more
sentences.

Also displayed on the pacing control page is a display 290 of a
desired reading pace. A display 292 of an estimated completion time
in accordance with the desired reading pace is also given. The desired
5 reading pace is controlled by the user using a graphical slider bar 294.
The pages of the text in the book are automatically paced by a pacing
routine which is enabled and disabled by a graphical switch 296. In
one embodiment, each page of text is displayed for a duration
commensurate with the desired reading rate controlled by the
10 graphical slider bar 294. The user returns to the title page from the
pacing control page by selecting the second hot spot portion 178, i.e.
the page back portion, of the touchscreen 130.

FIG. 16 is an illustration of the title page of the book which
depicts other user-initiated options. The user can return to a book-
15 marked page by selecting the bookmark graphic 182. The user can
return to the library screen by selecting the fourth hot spot portion
184, i.e. the close book portion, of the touchscreen 130. The user can go
to the first page of the book by selecting the first hot spot portion 170,
i.e. the advance page portion, of the touchscreen 130.

20 FIG. 17 is an illustration of a page marked by a dog ear in an
embodiment of the electronic book. The user initiates a dog ear
command by performing a predetermined user-initiated event. An
example of such an event includes a user touching an upper corner
portion of the touchscreen 130, such as the fifth hot spot portion 186
25 defined earlier.

If the page is not dog-eared, then a brief touching of the upper
corner portion 186 causes a dog ear graphic 300 to be displayed in the
upper corner portion. In addition, an indication that this page has been
dog-eared is stored either in the removable machine-readable storage-
30 medium 136 or the internal machine-readable storage medium 154.

If the user touches the upper corner portion 186 of a page
already marked with a dog ear, or if the upper corner portion 186 is
held for a duration greater than a predetermined threshold, then a dog
ear dialog box is opened.

35 FIG. 18 is an illustration of a dog ear dialog box used in
embodiments of the electronic book. A dog ear dialog box 302 is
displayed on touchscreen 130. The dog ear dialog box 302 displays a

0 list 304 of all dog-eared pages. A user can immediately go to one of the
dog-eared pages on the list 304 by touching a display of a selected page
number.

The dog ear dialog box 302 also displays an option 306 to display
marks 308 along an edge 310 of the page. Thereafter, a user can touch
5 any of the marks 308 to move quickly to a corresponding one of the
dog-eared pages. In the example illustrated in FIG. 18, a mark 312
corresponds to marked page 1, a dog ear 314 corresponds to marked
page 35, a mark 316 corresponds to marked page 94, a mark 318
corresponds to marked page 111, and a mark 320 corresponds to
10 marked page 120. In a preferred embodiment, page one is always
marked with a dog ear so that a user can quickly return thereto using
either the marks 308 or the dog ear dialog box 302.

Upon receiving a user-initiated event while the dog ear dialog box
302 is displayed, the dog ear dialog box 302 is removed to show the
15 selected page of the book.

FIG. 19 is an illustration of a user selecting a portion of a page of
text. A portion 330 is selected by a user-initiated event of sliding his
finger 212 (or other pointing member such as a stylus) from a first
position 332 to a second position 334. Upon its selection, the portion
20 330 of the text is highlighted in a predetermined manner. The portion
330 of the text can be highlighted in color if the touchscreen 130 is
capable of a color display. Alternatively, the portion 330 of the text
can be highlighted using grey scale shading, reverse video, or
underlining. An option selection dialog box is then displayed on the
25 touchscreen 130 to provide the user a number of text marking options.

FIG. 20 is an illustration of an option selection dialog box used in
embodiments of the electronic book. An option selection dialog box
340 is displayed on the touchscreen 130 in a location out of the way of
the portion 330 of the text that is marked when possible. The option-
30 selection dialog box 340 includes a plurality of text marking options
including a note capture option 342, a highlighting option 344, a quote
capture option 346, and a set bookmark option 348.

Briefly, the note capture option 342 allows a user to type in notes
associated with the portion 330 of the text. The highlighting option
35 344 leaves the portion 330 of the text highlighted, and stores an
indication of this highlighting so that any subsequent return to this
page displays the portion 330 as being highlighted. The quote capture

0 option 346 allows a user to store the portion 330 of the text along with
source data, such as the name of the author of the book or the title of
the book, in the internal machine-readable storage medium 154. The
set bookmark option 348 can be selected to add a bookmark to the
current page. If the page already has a bookmark, then a number of
5 bookmark management options similar to options used for the dog ear
command are provided to the user.

FIG. 21 is an illustration of an annotation display used in
embodiments of the electronic book. The annotation display is
provided in response to a user selecting the note capture option 342
10 illustrated in FIG. 20. After receiving a user-initiated event indicative
of selecting the note capture option 342, a soft keyboard 360 is
displayed on the touchscreen 130. The soft keyboard 360 includes
alphanumeric keys and symbolic keys along with a close key and a
notes collection key.

15 A plurality of keystroke events are received by the soft keyboard
360 to form an annotation. As the keystroke events are received, a
plurality of characters corresponding thereto are displayed in a
window 362 on the touchscreen 130.

The user selects the close key on the soft keyboard 360 upon
20 completing the annotation. In response to selecting the close key, the
electronic book removes the soft keyboard 360 and the window 362
from the touchscreen 130 and displays a note marker icon to indicate
that the page has an annotation associated therewith.

The notes collection key on the soft keyboard 360 commands the
25 electronic book to communicate the annotation to an external device
such as a personal computer. The personal computer can be interfaced
to the electronic book either wirelessly via the antenna 158 and the
radio frequency modem 160 shown in FIG. 3, using a wire-based
connection via the data interface 156, or using an infrared link. —

30 An annotation can also be in the form of an image of pixels which
overlays the page of the text. The pixels can be drawn on the
touchscreen 130 using a pointing device. The pixels can be stored in a
pixel-map form for subsequent viewing or for subsequent conversion
to text using a handwriting recognition method.

35 As another option, an accessory keyboard can be added to the
electronic book to enter the annotation as well as other information.

FIG. 22 is an illustration of a marker used to indicate that a page

0 has an annotation associated therewith. The page illustrated in FIG. 22
results after the user enters the annotation and selects the close key
from the soft keyboard 360 as illustrated in FIG. 21. As shown, the
page in FIG. 22 no longer has the soft keyboard 360 and the window
362 displayed thereon. However, a note marker icon 370 is displayed
5 in a lower corner of the page. The user can view the annotation
associated with this page by selecting the note marker icon 370.
Selecting the note marker icon 370 has the same effect as selecting the
note capture option 342 as shown in FIG. 20.

Further, an annotation can be indicated by underlining or
10 highlighting the portion of the text associated with the annotation. The
annotation can be viewed in a hypertext-type manner by selecting the
portion of text.

FIG. 23 is an illustration of a user selecting a set bookmark option
in the option selection dialog box. The user selects the set bookmark
15 option 348 by touching the displayed text associated therewith using
his or her finger 212 or other pointing member. If this page had
already included a bookmark, then a bookmark management dialog box
is displayed similar to the one used for the dog ear command. Since
the page illustrated in FIG. 23 does not have a bookmark associated
20 therewith, the selection of the set bookmark option 348 causes a
bookmark to be added to the page. In a preferred embodiment, only
one page is bookmarked within each book.

FIG. 24 is an illustration of the page of FIG. 23 having a bookmark
displayed thereon. A bookmark icon 380 is displayed in an upper
25 portion of the page to indicate that the page has been bookmarked.

It is noted that pointing devices other than an individual's finger
may be utilized to generate user-initiated events indicative of desired
selections using the touchscreen 130. For example, a stylus or the like
can be utilized to select desired portions of the touchscreen 130.

30 It is also noted that various types of graphical controls can be
utilized to control settings and parameters of the electronic book.
These graphical controls include, but are not limited to, graphical
buttons, checkboxes, radio buttons, scroll bars, slider bars, pop-up
menus, and dialog boxes.

35 Next, a description of steps which are performed by the various
components of the electronic book to provide its features and
functionality is presented. These operational steps are performed on or

0 with the aid of the processor 152 illustrated in FIG. 3. The processor
152 is directed to function in a manner in accordance with these
operational steps based upon a computer program or other form of
software or firmware stored in a computer readable memory. The
computer readable memory can be contained with the processor 152,
5 within the internal machine-readable memory 154, or within a
separate machine-readable storage medium in communication with the
processor 152.

It is noted that the order in which the steps are described are
indicative of one embodiment of the present invention, and that
10 alternative embodiments of the present invention may perform the
steps in a different order to achieve the same functionality.

FIG. 25 is a flow diagram of an event loop performed in an
embodiment of the electronic book. As indicated by block 400, a step
of executing a library graphical user interface routine is performed.
15 The library graphical user interface routine provides a virtual library
to allow a user to select a book to read from a plurality of books within
a library, and/or access an information service or world-wide web page
as previously described. The plurality of books can be contained in one
or more removable machine-readable storage media and/or the
20 internal machine-readable storage medium.

Upon selecting a desired book, a step of executing a routine to
display one or more pages of text and graphics from the desired book is
performed as indicated by block 402. The routine to display the pages
of text is executed until a predetermined user-initiated event is
25 received to exit the routine. As indicated by block 404, if a close book
event is received, then flow of the event loop is directed back to the
step of executing the library graphical user interface routine in block
400.

If a page back event is received when the current page of text
30 being read is page one, then a step of displaying a title page of the book
is performed as indicated by block 406. The title page provides a
number of control options available to a user. The user selects a
desired control option based upon a user-initiated event. Block 408
indicates a step of receiving this user-initiated event.

35 Based upon the user-initiated event which is received, flow of the
event loop is directed to one of a number of subroutines in a step
indicated by block 410. If the received event is indicative of the user

0 selecting the pacing control option, then a step of executing a pacing
control routine is performed as indicated by block 412. If the received
event is indicative of the user selecting the font selection option, then a
step of executing a font selection routine is performed as indicated by
block 414. If the received event is indicative of the user selecting the
5 system control option, then a step of executing a system control
subroutine is performed as indicated by block 416. If the received
event is indicative of the user selecting the RF link option, then a step
of executing an RF link subroutine is performed as indicated by block
420. Upon completing either the pacing control subroutine, the font
10 selection routine, the system control routine, or the RF link routine,
flow of the event loop is directed back up to block 406 wherein the
step of displaying the title page is performed.

If the received event from block 408 is indicative of the user
selecting the read-to-me option, then a step of executing a read-to-me
15 routine is performed as indicated by block 422. Flow of the event loop
is then directed back to block 402 to execute the routine to display
pages of text from the book. The execution of the read-to-me routine in
block 422 provides a spoken, auditory display of the text in addition to
the visual display of the text in block 402.

20 If the event received in the step of block 408 is an advance page
event, then a step of setting the current page to page one is performed
as indicated by block 424. If the received event is indicative of the
user selecting a bookmark displayed on the title page, then a step of
setting the current page to a previously bookmarked page is performed
25 as indicated by block 426. After the current page is set in either of the
steps indicated by blocks 424 and 426, then flow of the event loop is
directed back to the step of executing the routine to display pages of
text indicated by block 402.

30 Finally, if the event received in block 408 is indicative of a close-
book event, then flow of the event loop is directed back to block 400 to
perform a step of executing the library graphical user interface routine.

FIG. 26 is a flow diagram of steps performed in an embodiment of
a library graphical user interface routine for use in the electronic book.
These steps can be performed in executing the library graphical user
35 interface routine indicated by block 400 in FIG. 25. The steps provide
a method of selecting a book for reading in an electronic book where
the book is selected from a plurality of books in a library.

0 As indicated by block 430, a step of displaying a rearward
graphical book representation having a graphical spine portion is
performed. A step of displaying a forward graphical book
representation in front of the rearward graphical book representation
is performed as indicated by block 432. The forward graphical book
5 representation has a graphical spine portion and a graphical front cover
portion.

As indicated by block 434, a step of displaying a title of a first
book of the plurality of books on the forward graphical book
representation is performed. The title of the first book can be
10 displayed anywhere on the forward graphical book representation.
However, in a preferred embodiment, the title of the first book is
displayed on the graphical spine portion of the forward graphical book
representation. FIG. 5 illustrates an example of the rearward graphical
book representation 200 having the graphical spine portion 202, the
15 forward graphical book representation 204 having the graphical spine
portion 206 and the graphical front cover portion 208, and the title 210
displayed on the forward graphical book representation 204.

With reference again to FIG. 26, a step of receiving a first user-
initiated event in which a portion of the rearward graphical book
20 representation is selected is performed as indicated by block 436. In a
preferred embodiment, the portion of the rearward graphical book
representation selected in this step is within the graphical spine
portion of the rearward graphical book representation. Upon receiving
the first user-initiated event, a step of displaying a title of a second
25 book of the plurality of books is performed as indicated by block 440.
Preferably, the title of the second book is displayed in place of the title
of the first book on the graphical spine portion of the forward graphical
book representation.

As indicated by block 442, a step is performed of receiving a -
30 second user-initiated event in which a portion of the forward graphical
book representation is selected. In a preferred embodiment, the
portion of the forward graphical book representation selected in this
step is within the front cover portion of the forward graphical book
representation. The reception of the second user-initiated event ends
35 the execution of the library graphical user interface routine, and flow is
directed to the routine to display pages of text from the second book.
Here, steps are performed of reading machine-readable data from a

0 machine-readable storage medium installed in the electronic book, the
machine-readable data being representative of text from the second
book, and displaying the text represented by the machine-readable
data.

5 It is noted that the steps indicated by blocks 436 and 440 can be
repeated to allow the user to rotate through the plurality of books.
When the first user-initiated event is received while a last of the
plurality of books is displayed, the next title displayed is that of the
first of the plurality of books.

10 It is preferred that steps of displaying and receiving user-
initiated events all be performed using the touchscreen 130 integrated
in the electronic book. However, in alternative embodiments of the
electronic book which include a series of buttons external to the
touchscreen 130, any of the above-described user-initiated events may
be received using these buttons.

15 FIGS. 27 and 28 show flow diagrams of an embodiment of the
routine to display pages of text in the electronic book. The steps
indicated in these flow diagrams are performed in one embodiment of
the step indicated by block 402 in FIG. 25.

20 Upon entering the routine, a step of displaying a current page of
the book is performed as indicated by block 450. The current page
includes text from the current page of the book, a graphical display of a
number of pages remaining in the book, a display of a bookmark
graphic if there is a bookmark associated with the current page, a dog
ear graphic if the current page is dog-eared, and a note marker icon if
25 there is an annotation associated with the current page. Optionally, the
current page includes graphics from the current page of the book.

After displaying the current page, a branching step is performed,
as indicated by block 452, based upon any user-initiated events which
are received. If a user-initiated event is received which selects a
30 portion of the text, a step of marking the portion of the text is
performed as indicated by block 454. The portion of the text can be
marked either by color or grey scale highlighting the portion of the
text, underlining the portion of the text, or displaying the portion of the
text in a reverse video form. The portion of the text can be selected
35 directly by a user sliding a finger or a stylus over the portion of the
text. Alternatively, the portion of the text can be selected indirectly by
a menu selection technique.

0 After the portion of the text has been marked, a step of displaying an option selection dialog box is performed as indicated by block 456. The option selection dialog box provides a plurality of options to the user, including a note capture option, a highlighting option, a quote capture option, and a set bookmark option.

5 As indicated by block 460, a step of receiving a user-initiated event indicative of a selection of one of the options is performed. Based upon the selection, a branching step is performed as indicated by block 462. If the note capture option is selected, then a step of executing an annotation subroutine is performed as indicated by block
10 464. If the quote capture option is selected, then a step of executing a quote capture subroutine is performed as indicated by block 466. If the highlighting option is selected, then a step of executing a highlighting subroutine is performed as indicated by block 470. If the set bookmark option is selected, then a step of executing a bookmark
15 subroutine is performed as indicated by block 472.

Upon completing the execution of either the annotation subroutine, the quote capture subroutine, the highlighting subroutine, or the bookmark subroutine, a step of determining whether a pacing mode is active is performed as indicated by block 474. If the pacing
20 mode is inactive, then flow of the routine is directed back to block 452 which performs a branching step based upon a received user-initiated event. If the pacing mode is active, then a step of determining whether a highlighting mode is active is performed as indicated by block 476. If the highlighting mode is active then a step of scrolling a highlight
25 across the current page is performed as indicated by block 480. Scrolling the highlight across the current page allows pacing of a user's scanning across the current page. A user can activate the highlighting mode to help enhance his or her reading speed.

The highlight which is scrolled across the page can be in the form
30 of either a color or grey scale highlight, an underlining of text, or a reverse video form of text. If the touchscreen 130 is capable of selective backlighting, then the highlight can be in the form of a selective backlighting of a reduced portion of the touchscreen 130.

After scrolling the highlight across the current page in block 480
35 or if the highlighting mode is inactive, then a step of determining whether it is time for displaying a subsequent page is performed as indicated by block 482. If the time has not yet come for displaying a

0 subsequent page, then flow is directed back to block 452. If the time
has arrived for displaying a subsequent page, then a step of updating
the current page is performed as indicated by block 484. Next, a step
of displaying a forward page turn in an animated matter is performed
as indicated by block 486. This step includes displaying an animated
5 sequence of images which simulates a forward flipping of a page. Flow
of the routine is then directed back to block 450 to display the new
current page.

With reference to block 452, if a user-initiated event is received
indicative of the user selecting the note marker icon, then the step of
10 executing the annotation routine indicated by block 464 is performed.
Thereafter, subsequent steps are performed beginning with the step
indicated by block 474.

With reference to the branching step performed in block 452, if a
dog ear user-initiated event is received, then a step of executing a dog
15 ear routine is performed as indicated by block 490. If the user-
initiated event is indicative of the user selecting the bookmark portion
of the page, then a step of executing a bookmark management routine
is performed as indicated by block 491. Thereafter, subsequent steps
are performed beginning with the step indicated by block 474.
20 Similarly, if no user-initiated events are received in block 452, then
flow of the routine is directed to the step indicated by block 474.

If the user-initiated event is indicative of the user selecting the
page back portion of the page, then flow from block 452 branches to a
step of decrementing the current page as indicated by block 492.
25 Further, a step of displaying a backward page turn in an animated
matter is performed as indicated by block 494. This step includes
displaying an animated sequence of images which simulates a
backward flipping of a page. The steps indicated by blocks 486 and
494 give the user the sense or feel that a page of information is being
30 turned in place, carrying forward the familiar paradigm of turning the
page on a standard paper book.

As indicated by block 496, a step of determining whether the
new current page is the title page is performed after the step of block
494. If the new current page is the title page, then execution of the
35 routine to display pages of text in the electronic book is completed as
indicated by block 500. If the new current page is any page but the
title page, then flow of the routine is directed back to block 450

0 wherein a step of displaying the new current page is performed.

If the user-initiated event is indicative of the user selecting the advance page portion of the page, then flow is directed from the step indicated by block 452 to a step of incrementing the current page as indicated by block 502. Further, a step of displaying a forward page
5 turn in an animated matter is performed is indicated by block 504. Flow of the routine is then directed back to block 450 wherein the new, incremented current page is displayed.

FIG. 29 is a flow diagram of steps performed to display a current page in the electronic book. These steps constitute one embodiment of
10 a method of performing the step indicated by block 450 in FIG. 27.

As indicated by block 510, a step of displaying text from the current page of the book is performed. The text is displayed in accordance with a primary font parameter and a primary size parameter. If there is any highlighting associated with a portion of the
15 text on the current page, then a step of displaying the portion of the text in a highlighted manner is performed as indicated by block 512. If any graphical information is included in the current page, then a step of displaying the graphical information is performed as indicated by block 513.

20 As indicated by block 514, a step of graphically displaying a number of pages remaining in the book is performed. The number of pages remaining in the book can be displayed in the sixth portion 188 of the touchscreen 130 as illustrated in FIG. 4. The number of pages remaining in the book can be graphically displayed using either an
25 image of a number of pages, a dark line as a drop shadow, or a group of parallel lines to indicate relative depth by page number in a given document. When the current page is one of the early pages in the book, the drop shadow or graphical image depth is relatively deep, indicating that there is a significant portion of the book remaining to be
30 read. When the current page is near the middle of the book, the drop shadow or graphical image depth is half as deep. When nearing the end of the book, the drop shadow or graphical image depth becomes very thin indicating that the reader is almost at the end of the book. As a result, the user can determine at a glance how much of the book
35 has been read, and their relative position within the book just as a standard paper book. As an alternative to using a top portion of the touchscreen for graphically displaying the number of pages remaining

0 in the book, a side edge and/or a bottom edge of the touchscreen 130
can be utilized to provide this graphical display.

As indicated by block 516, a step of determining if a bookmark is
associated with the current page is performed. If a bookmark is
associated with the current page, then a step of displaying a bookmark
5 graphic is performed as indicated by block 520.

As indicated by block 522, a step of determining if the current
page is dog-eared is performed. If the current page is dog-eared, then
a step of displaying a dog ear graphic is performed as indicated by
block 524.

10 As indicated by block 526, a step of determining whether an
annotation exists for the current page is performed. If there is an
annotation associated with the current page, then a step of displaying a
note marker icon is performed as indicated by block 530.

FIG. 30 is a flow diagram of steps performed in an embodiment of
15 an annotation routine. Such an annotation routine is executed in the
step indicated by block 464 in FIG. 28.

As indicated by block 540, a step of displaying a window for
displaying the annotation is performed. As indicated by block 542, a
step of displaying a soft keyboard on the touchscreen 130 is
20 performed. The soft keyboard is provided to receive a plurality of
keystroke events to form the annotation.

After displaying the soft keyboard and the annotation window, a
step of receiving a keystroke event is performed as indicated by block
544. As indicated by block 546, a branching operation is performed
25 based upon the keystroke event received in block 544. If the
keystroke event is indicative of the user selecting either an
alphanumeric key or a symbolic key on the soft keyboard, then a step
of displaying a character associated with the key is performed as
indicated by block 560. The character associated with the key is
30 displayed within the annotation window. After displaying the
character, flow of the routine is directed back to block 544 wherein a
subsequent keystroke event is received.

Referring back to the branching step indicated by block 546, if
the keystroke event is indicative of a user selecting the close key from
35 the soft keyboard, then a step of closing the soft keyboard is performed
as indicated by block 562. A step of closing the annotation window is
also performed, as indicated by block 564. As indicated by block 566,

0 a step of displaying a note marker icon on the page is performed. Thereafter, execution of the annotation subroutine is completed.

With reference again to the branching step performed in block 546, if the keystroke event is indicative of the user selecting the notes collection key, then a step of communicating the annotation to an
5 external personal computer is performed as indicated by block 570. After communicating the annotation to the personal computer, flow of the routine is directed back to block 544 wherein a subsequent keystroke event is received.

FIG. 31 is a flow diagram of steps performed in an embodiment of
10 a quote capture subroutine. Such a quote capture subroutine can be performed to provide the step indicated by block 466 in FIG. 28.

Prior to entering the quote capture subroutine, a user-initiated event was received in the electronic book which selects a portion of the text displayed on the touchscreen. After receiving the user-initiated
15 event, a plurality of text marking options, including a quote capture option, is displayed, and a user-initiated event indicative of a user selecting the quote capture option is received.

As indicated by block 580, a step of storing quote data representative of the portion of the text is performed. The quote data
20 is stored in the internal machine-readable storage medium 154 illustrated in FIG. 3.

As indicated by block 582, a step of storing source data which identifies the source of the quote data is performed. The source data can be representative of the author of the book, the title of the book, a
25 copyright date of the book, and/or a publisher of the book. The source data is stored in the internal machine-readable storage medium 154 from FIG. 3.

As indicated by block 584, a step is performed of maintaining the quote data and the source data in the internal machine-readable
30 storage medium when the removable machine-readable storage medium is removed from the electronic book. As a result of this step, subsequent steps can be performed based upon the quote data and the source data when the removable machine-readable storage medium is removed. Specifically, a step of retrieving the quote data and the
35 source data from the internal machine-readable storage medium can be performed when the removable machine-readable storage medium is removed from the electronic book. Thereafter, a step of displaying the

0 portion of the text represented by the quote data and source information represented by the source data can be performed.

FIG. 32 is a flow diagram of steps performed in an embodiment of a dog ear subroutine. Such a dog ear subroutine is executed in the step indicated by block 490 in FIG. 27.

5 As indicated by block 590, a step is performed of determining a duration in which a dog ear portion of the touchscreen is held. A step of comparing the duration to a predetermined threshold is performed as indicated by block 592. The predetermined threshold can be about a second. If the duration is less than the predetermined threshold, then
10 a step of determining whether the current page has a dog ear is performed as indicated by block 594. If the current page does not have a dog ear, then a step of storing an indication that the current page be dog-eared is performed as indicated by block 596. Further, a step of displaying a dog ear graphic in an upper corner portion of the
15 touchscreen 130 is performed as indicated by block 600. Thereafter, execution of the dog ear subroutine is completed.

With reference to blocks 592 and 594, if the duration is greater than or equal to the predetermined threshold or if the current page is already dog-eared, then a step of displaying a dog-eared dialog box is
20 performed as indicated by block 602. Within the dog-eared dialog box, a list of all marked pages is displayed. Further, an option to show marks corresponding to all of the marked pages along an edge of each page is displayed.

As indicated by block 604, a user-initiated event is received. As
25 indicated by block 606, a branching step is performed based upon the user-initiated event received. If the user-initiated event is indicative of a user selecting a page number from the list of marked pages, then a step of setting the current page to the selected page number is performed as indicated by block 610. If the user-initiated event is
30 indicative of the user selecting the marking option, then a step of displaying marks corresponding to the dog-eared pages along an edge of the page is performed as indicated by block 612.

FIG. 33 is a flow diagram of steps performed in an embodiment of a pacing control subroutine. The pacing control subroutine is executed
35 in the step indicated by block 472 in FIG. 25.

As indicated by block 620, a step of determining a number of pages remaining in the book is performed. As indicated by block 622,

0 a step of determining a current reading pace of the user is performed.

Based upon the number of pages remaining in the book, a step of calculating one or more estimated completion times is performed as indicated by block 624. A first estimated completion time can be calculated by dividing the number of words or pages remaining in the
5 book by the current reading pace of the user. As a result, the first estimated completion time estimates how long it would take the user to complete the book at his or her current reading pace. A second estimated completion time is calculated by dividing the number of words or pages remaining in the book by a desired reading pace. The
10 second estimated completion time estimates how long it would take the user to complete the book at the desired reading pace.

As indicated by block 626, a step of displaying each estimated completion time is performed. Each estimated completion time can be displayed within a corresponding sentence as illustrated in FIG. 15.

15 As indicated by block 630, a step of calculating a necessary reading pace to satisfy a predetermined reading goal is performed. The predetermined reading goal can be in the form of a time duration within which a user wishes to complete the pages remaining in the book. Here, the necessary reading pace is calculated by dividing the
20 number of pages remaining in the book by the time duration. A step of displaying the necessary reading pace to satisfy the reading goal is then performed as indicated by block 632.

As indicated by block 634, a step of displaying one or more graphical pacing controls is performed. As illustrated in FIG. 15, the
25 one or more graphical pacing controls can include a graphical slider bar such as the graphical slider bar 294 used for modifying the desired reading pace, and a graphical switch such as the graphical switch 296 which is used for enabling and disabling an automatic pacing of the text using a pacing routine.

30 As indicated by block 636, a user-initiated event is received. As indicated by block 640, if the user-initiated event is indicative of the user selecting the page back portion of the touchscreen 130, then execution of the pacing control subroutine is terminated. Upon terminating the pacing control subroutine, the system control page is
35 displayed on the touchscreen 130.

If the user-initiated event is not indicative of the user selecting the page back portion, then a step of updating a pacing parameter

0 based on the user-initiated event is performed as indicated by block
642. Examples of the pacing parameter include the desired reading
pace and the reading goal. After updating the pacing parameter, flow
of the subroutine is directed back to block 624 to recalculate an
estimated completion time and the necessary reading pace.

5 FIG. 34 is a flow diagram of steps performed in an embodiment of
the font selection subroutine. The font selection subroutine is executed
in block 414 in the event loop of FIG. 25.

As indicated by block 650, a step of displaying a plurality of
words using a corresponding plurality of combinations of different
10 fonts and different sizes is performed. More specifically, each word is
displayed using a specific font and a specific size in accordance with the
combination corresponding thereto. Optionally, the step of displaying
the plurality of words can include displaying a respective font name for
each of the combinations. As another option, the step of displaying the
15 plurality of words can include displaying a single textual expression
using the corresponding plurality of combinations.

As indicated by block 652, a step of receiving a user-initiated
event indicative of the user selecting one word of the plurality of
words is performed. This selection indicates which font/size
20 combination is desired by the user.

As indicated by block 654, a step of updating a primary font
parameter and a primary size parameter is performed. The primary
font parameter and the primary size parameter are updated in
accordance with the font/size combination selected by the user. As
25 indicated by block 656, a step of automatically returning to displaying
the title page is performed after receiving the user-initiated event
selecting the one word. Thereafter, a subsequent step of displaying
text of a book includes displaying the text using the primary font in a
size at least the primary size.

30 FIG. 35 is a flow diagram of steps performed in an embodiment of
the system control subroutine. The system control subroutine is
executed in the step indicated by block 416 in the event loop of FIG.
25.

As indicated by block 660, a step of displaying a plurality of
35 graphical controls for setting system parameters is performed. The
system parameters can include display parameters such as a contrast
parameter, a tint parameter, and a color parameter. The system

0 parameters can also include a sound parameter.

As indicated by block 662, a step of receiving a user-initiated event is performed. If the user-initiated event is indicative of the user selecting the page back portion of the touchscreen, as indicated by block 664, then execution of the system control subroutine is
5 completed. For other user-initiated events, a step of updating a system parameter is performed as indicated by block 668.

Thus, there has been described herein a concept, as well as several embodiments including preferred embodiments of an electronic book and a graphical user interface for selecting a book to read
10 therewith.

Because the various embodiments of the present invention provide a graphical user interface to allow a user to select a desired book for reading in an electronic book, they provide a significant improvement in that the user can easily select the desired book in an
15 intuitive and efficient manner.

Additionally, the various embodiments of the present invention provide an intuitive approach for the user to scroll through the library of books until the desired book is pulled into view and to open the
20 desired book for reading, using two graphical book representations.

It will be apparent to those skilled in the art that the disclosed invention may be modified in numerous ways and may assume many
embodiments other than the preferred form specifically set out and described above.

Accordingly, it is intended by the appended claims to cover all
25 modifications of the invention which fall within the true spirit and scope of the invention.

What is claimed is:

0 Claims

1. A method of selecting a book for reading in an electronic book, the book selected from a plurality of books, the method comprising the steps of:

- 5 (a) displaying a first graphical book representation;
(b) displaying a second graphical book representation;
(c) displaying a title of a first book of the plurality of books on the second graphical book representation;
(d) receiving a first user-initiated event in which a portion of the
10 first graphical book representation is selected;
(e) displaying a title of a second book of the plurality of books in place of the title of the first book on the first graphical book representation in response to receiving the first user-initiated event;
(f) receiving a second user-initiated event in which a portion of
15 the second graphical book representation is selected;
(g) reading machine-readable data from a machine-readable storage medium installed in the electronic book in response to receiving the second user-initiated event, the machine-readable data representative of text from the second book; and
20 (h) displaying the text represented by the machine-readable data.

2. The method of claim 1 wherein the steps of displaying in steps (a), (b), (c), (e), and (h) are performed using a touchscreen integrated in the electronic book.
25

3. The method of claim 2 wherein the first user-initiated event is generated by a user touching a portion of the touchscreen on which the first graphical book representation is displayed, and wherein the second user-initiated event is generated by the user touching a
30 portion of the touchscreen on which the second graphical book representation is displayed.

4. The method of claim 1 wherein the second graphical book representation is displayed in front of the first graphical book
35 representation.

- 0 5. An electronic book comprising:
 a book-shaped housing having a first housing member pivotably
 connected to a second housing member to facilitate opening and closing
 in a book-like manner;
 an interface which receives a removable machine-readable
5 storage medium;
 an internal machine-readable storage medium;
 wherein at least one of the removable machine-readable storage
 medium and the internal machine-readable storage medium contains
 machine-readable data representative of text from a plurality of books;
10 a touchscreen integrated in the book-shaped housing to be
 accessible when the book-shaped housing is opened in the book-like
 manner, the touchscreen operative to display a first graphical book
 representation and a second graphical book representation, the second
 graphical book representation having a title of a first book of the
15 plurality of books displayed thereon;
 a processor housed by the book-shaped housing and in
 communication with the interface, the internal machine-readable
 storage medium, and the touchscreen; and
 wherein the touchscreen displays a title of a second book of the
20 plurality of books in place of the title of the first book in response to a
 first user-initiated event in which a portion of the first graphical book
 representation is selected, and wherein the processor reads the
 machine-readable data representative of text from the second book
 and commands the touchscreen to display the text in response to
25 receiving a second user-initiated event in which a portion of the second
 graphical book representation is selected.

6. The electronic book of claim 5 wherein the second graphical
 book representation has a graphical spine portion, and wherein the title
30 of the first book is displayed on the graphical spine portion of the
 second graphical book representation.

7. The electronic book of claim 6 wherein the title of the
 second book is displayed on the graphical spine portion of the second
35 graphical book representation.

- 0 8. The electronic book of claim 5 wherein the first graphical
book representation has a graphical spine portion, and wherein the
portion of the first graphical book representation selected in the first
user-initiated event is within the graphical spine portion.
- 5 9. The electronic book of claim 5 wherein the second graphical
book representation has a graphical front cover portion, and wherein
the portion of the second graphical book representation selected in the
second user-initiated event is within the graphical front cover portion.
- 10 10. The electronic book of claim 5 wherein the first user-
initiated event is generated by a user touching a portion of the
touchscreen on which the first graphical book representation is
displayed, and wherein the second user-initiated event is generated by
the user touching a portion of the touchscreen on which the second
15 graphical book representation is displayed.

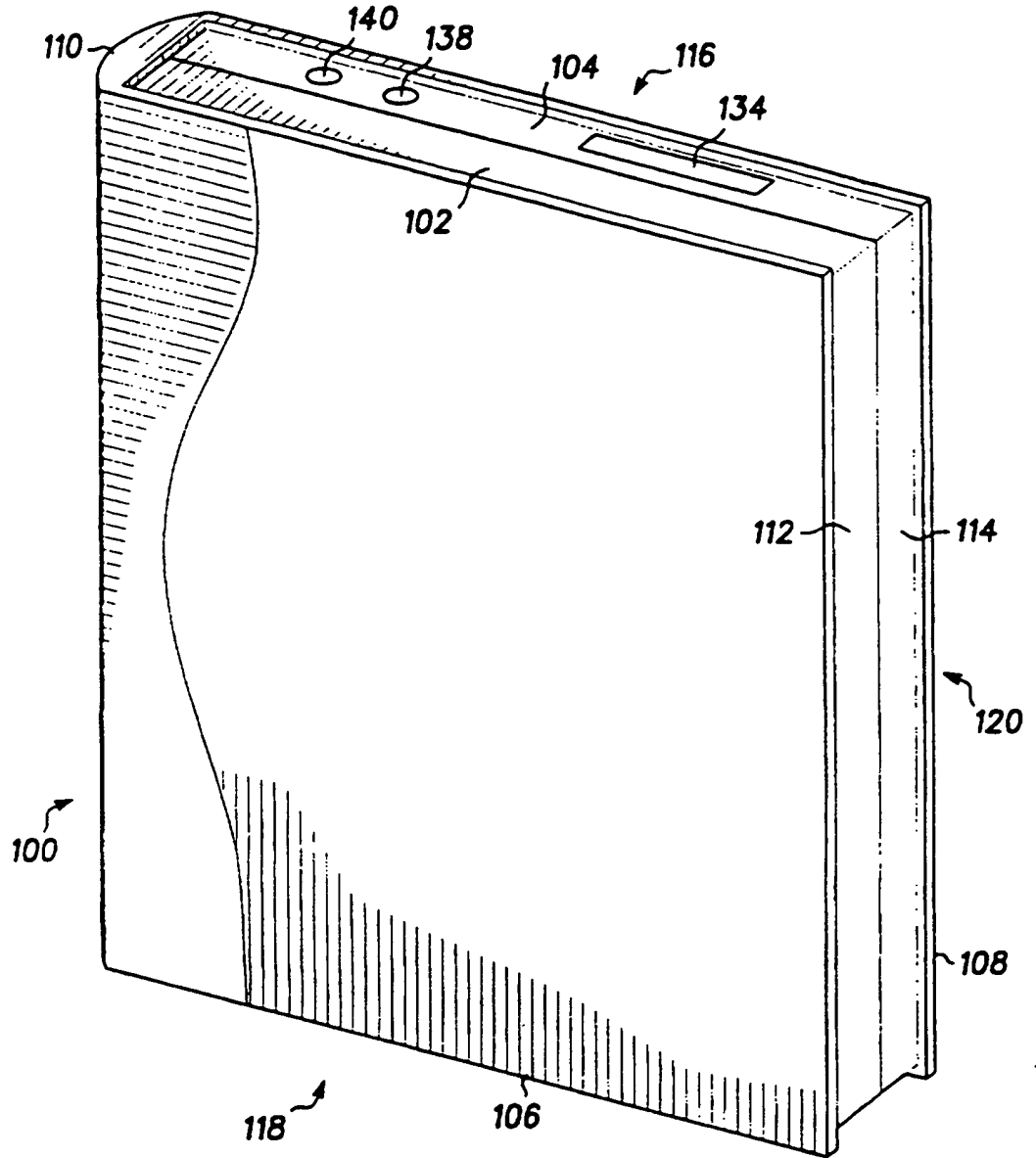

FIG. 1

2/29

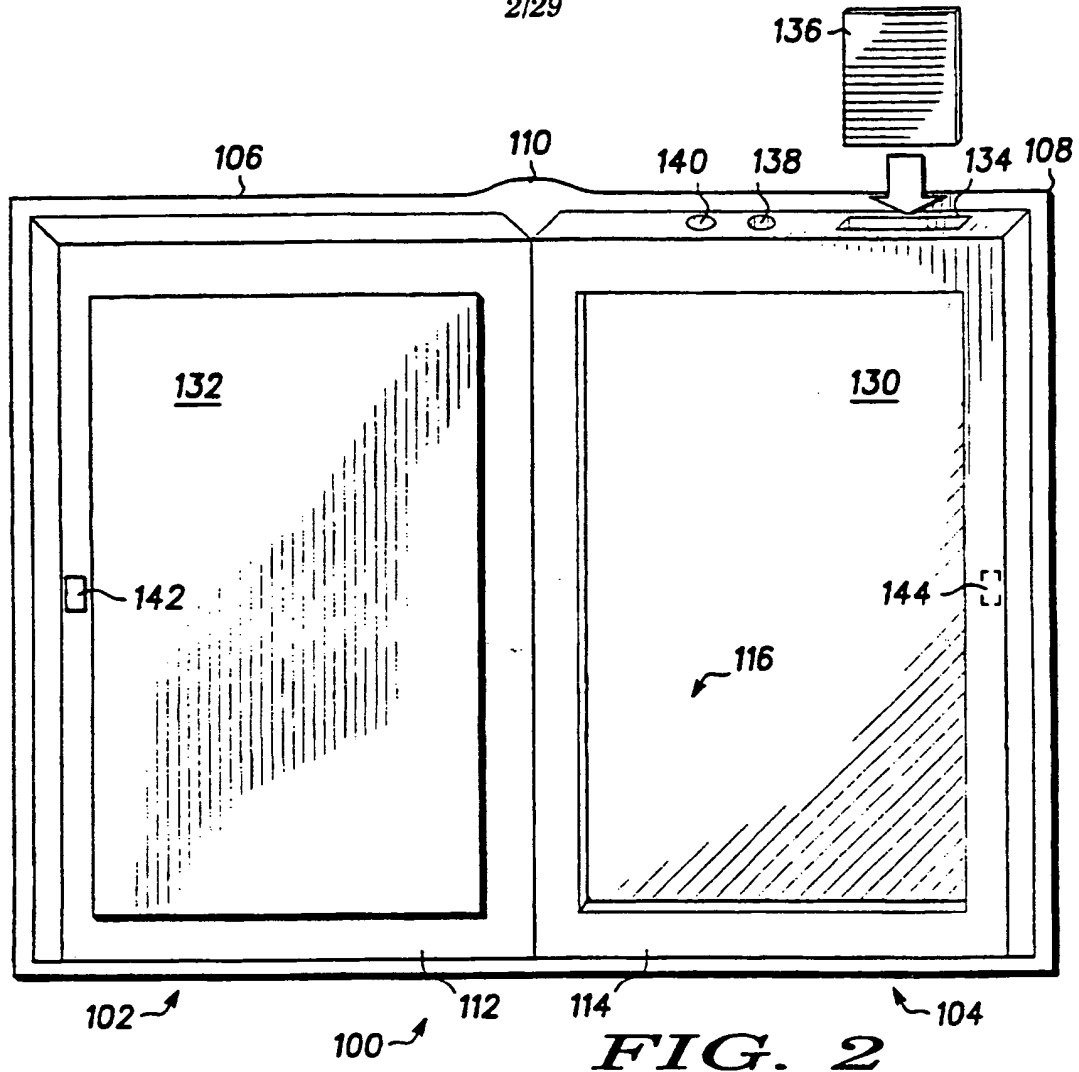

FIG. 2

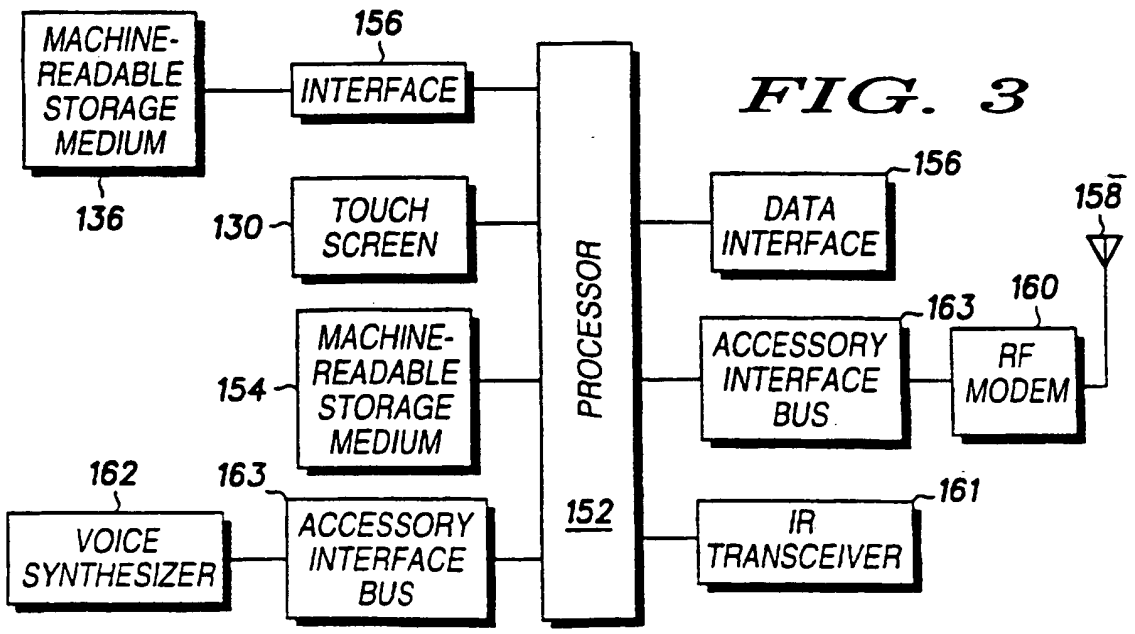

FIG. 3

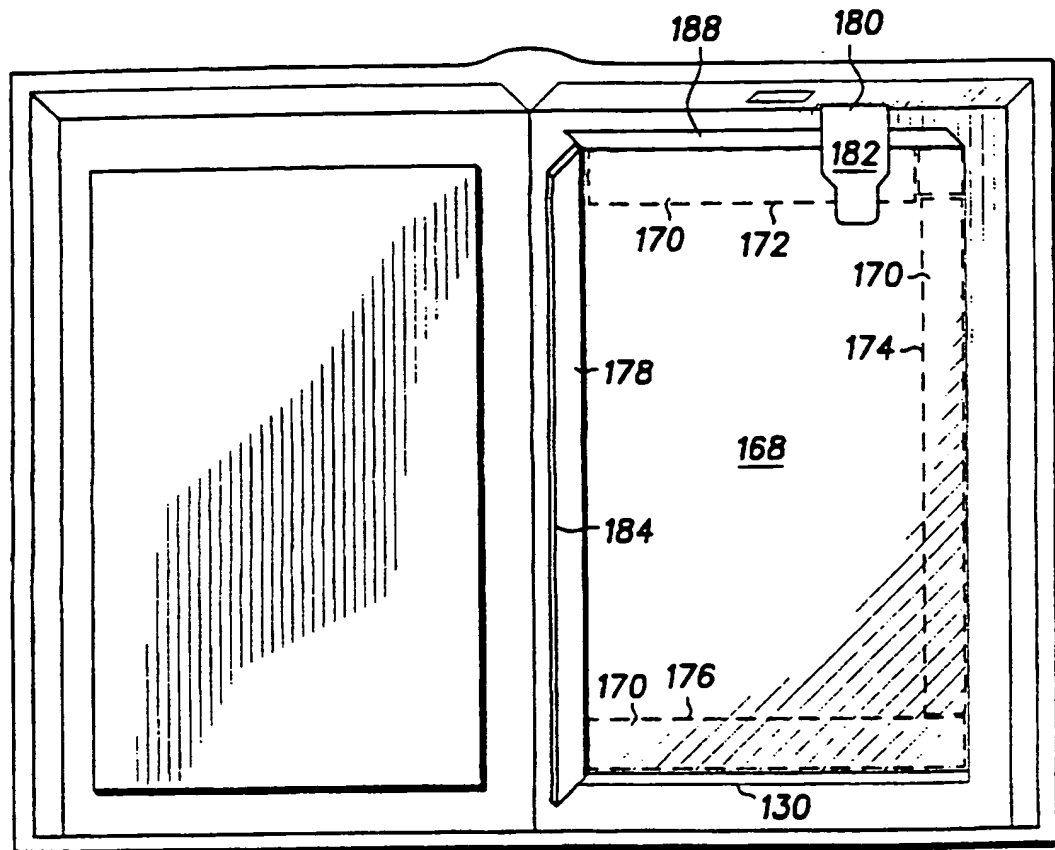

FIG. 4

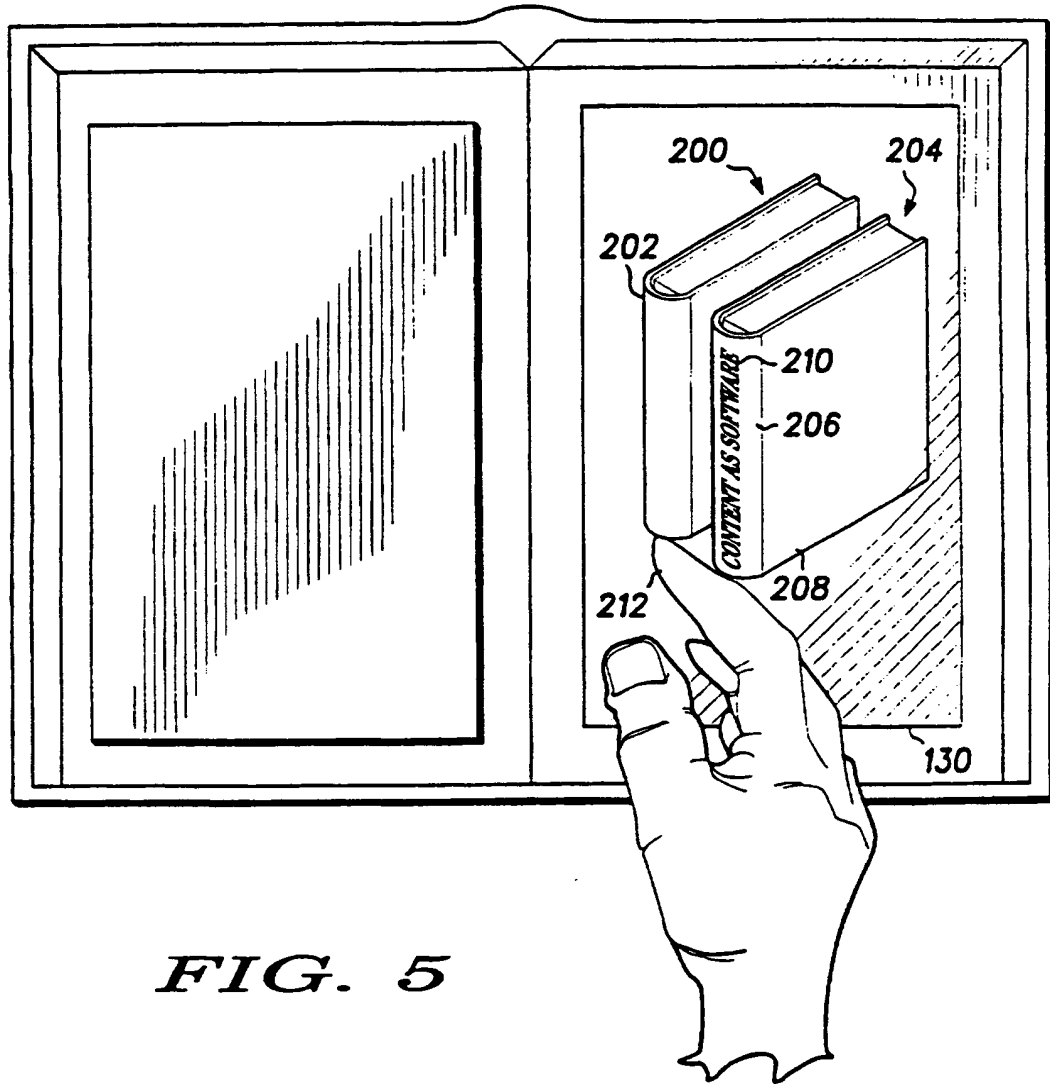

FIG. 5

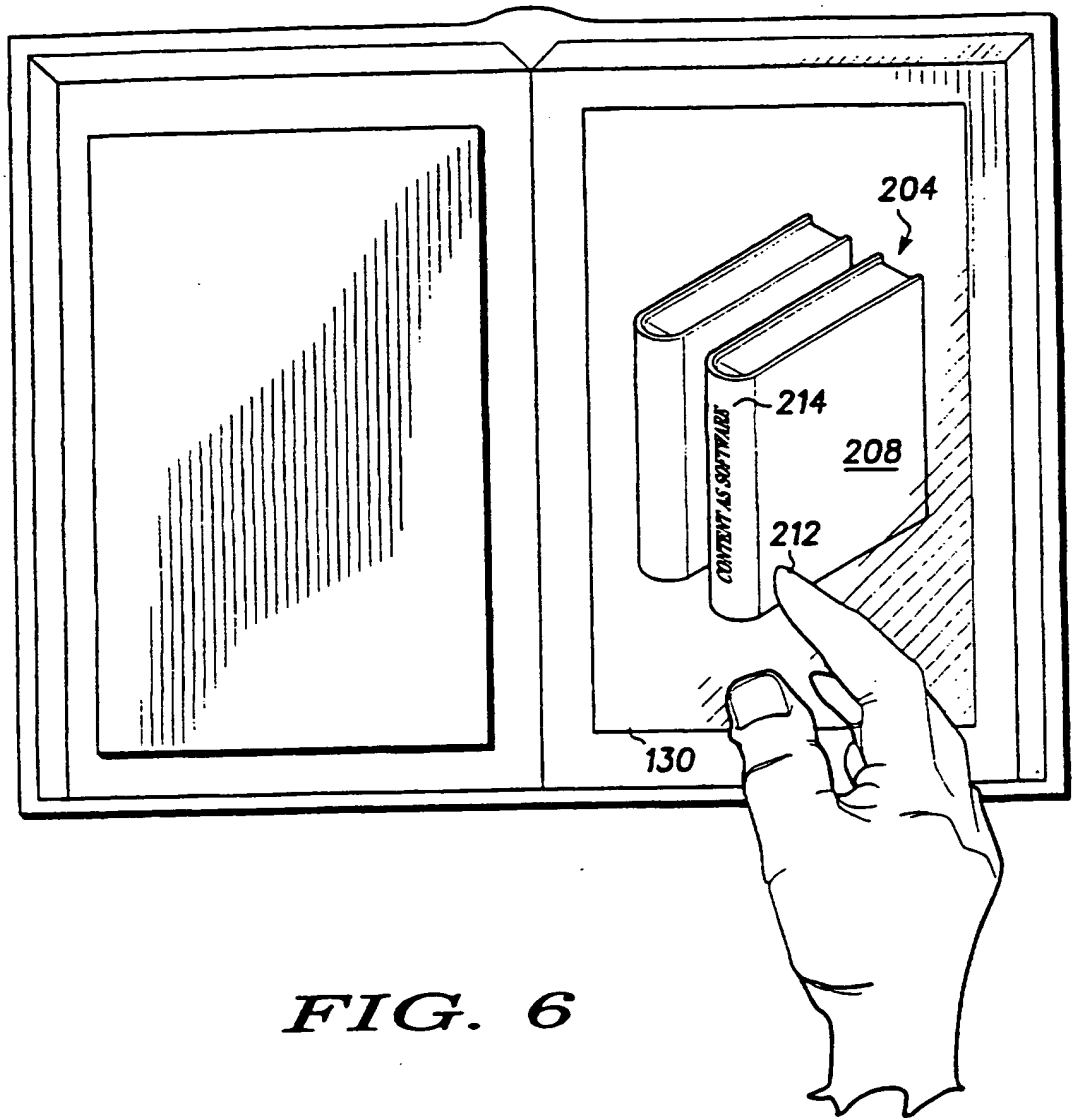

FIG. 6

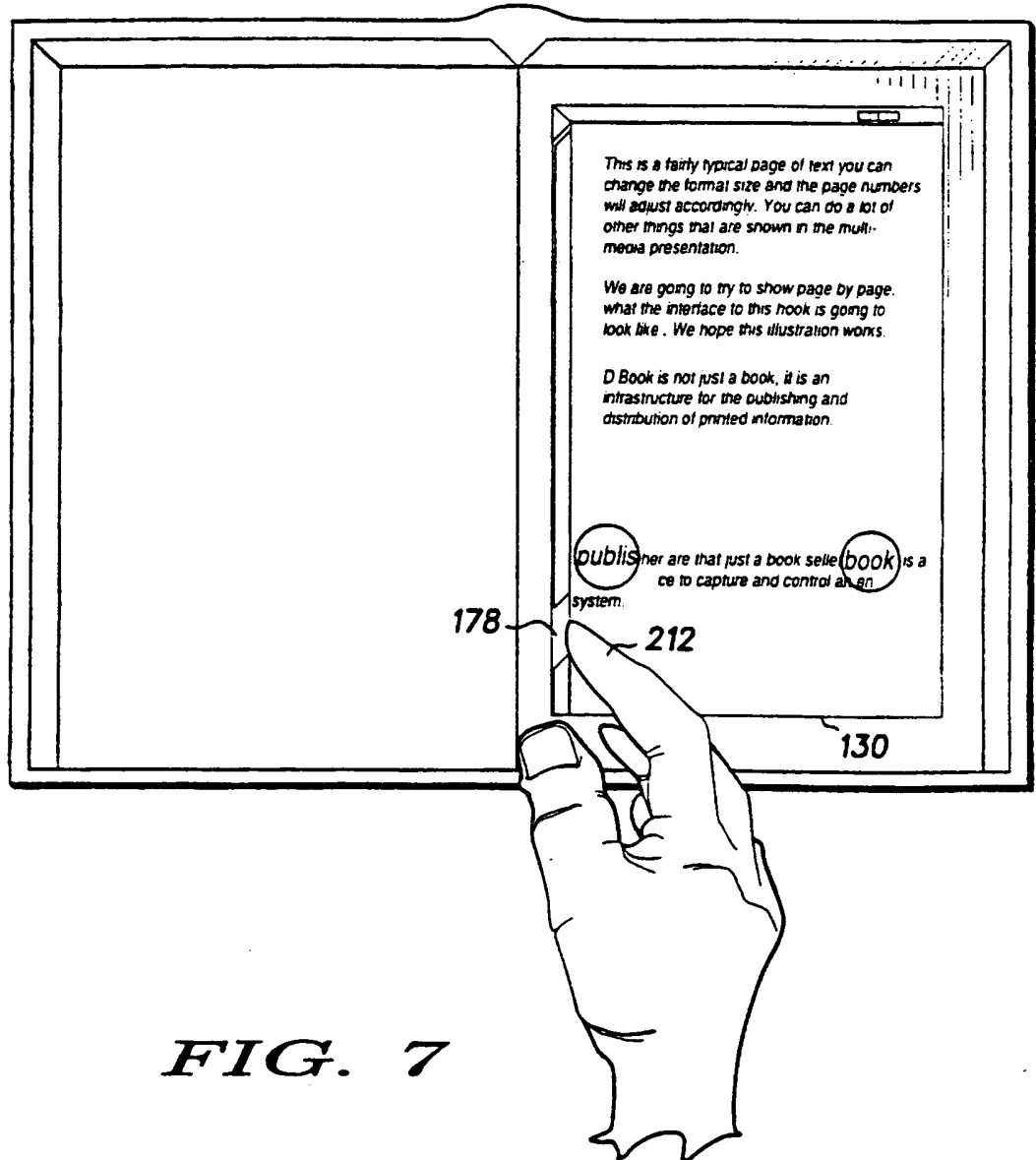

FIG. 7

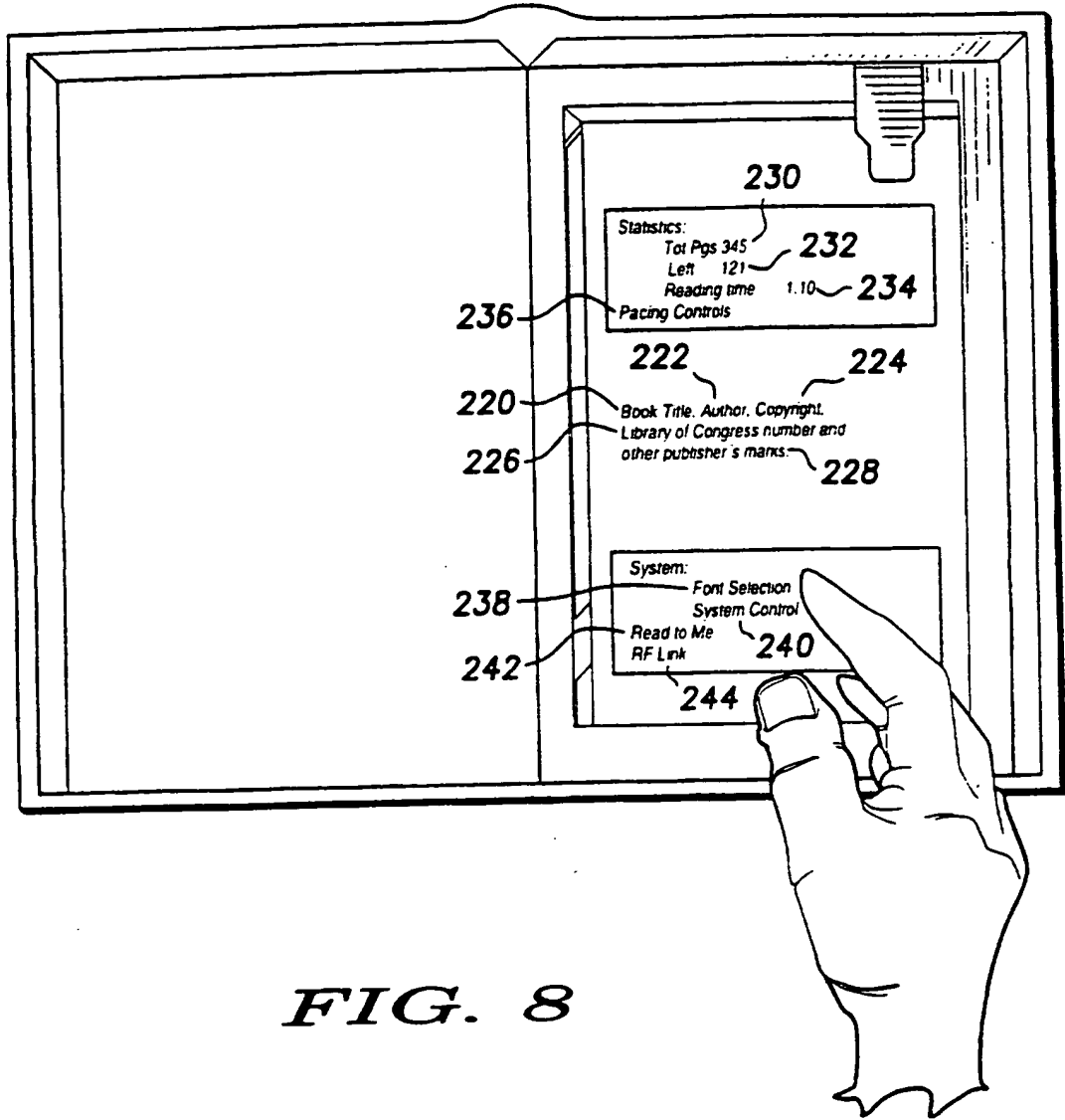

FIG. 8

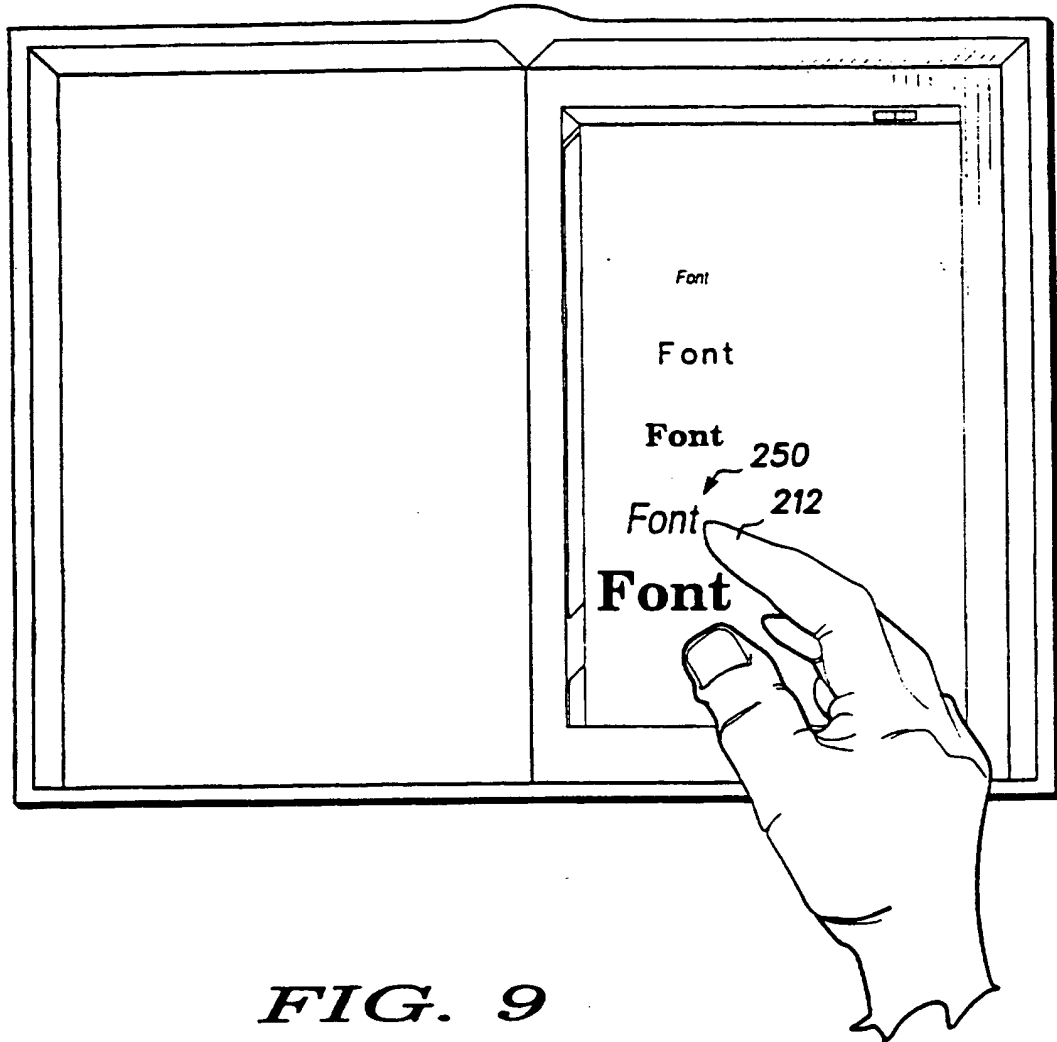

FIG. 9

9/29

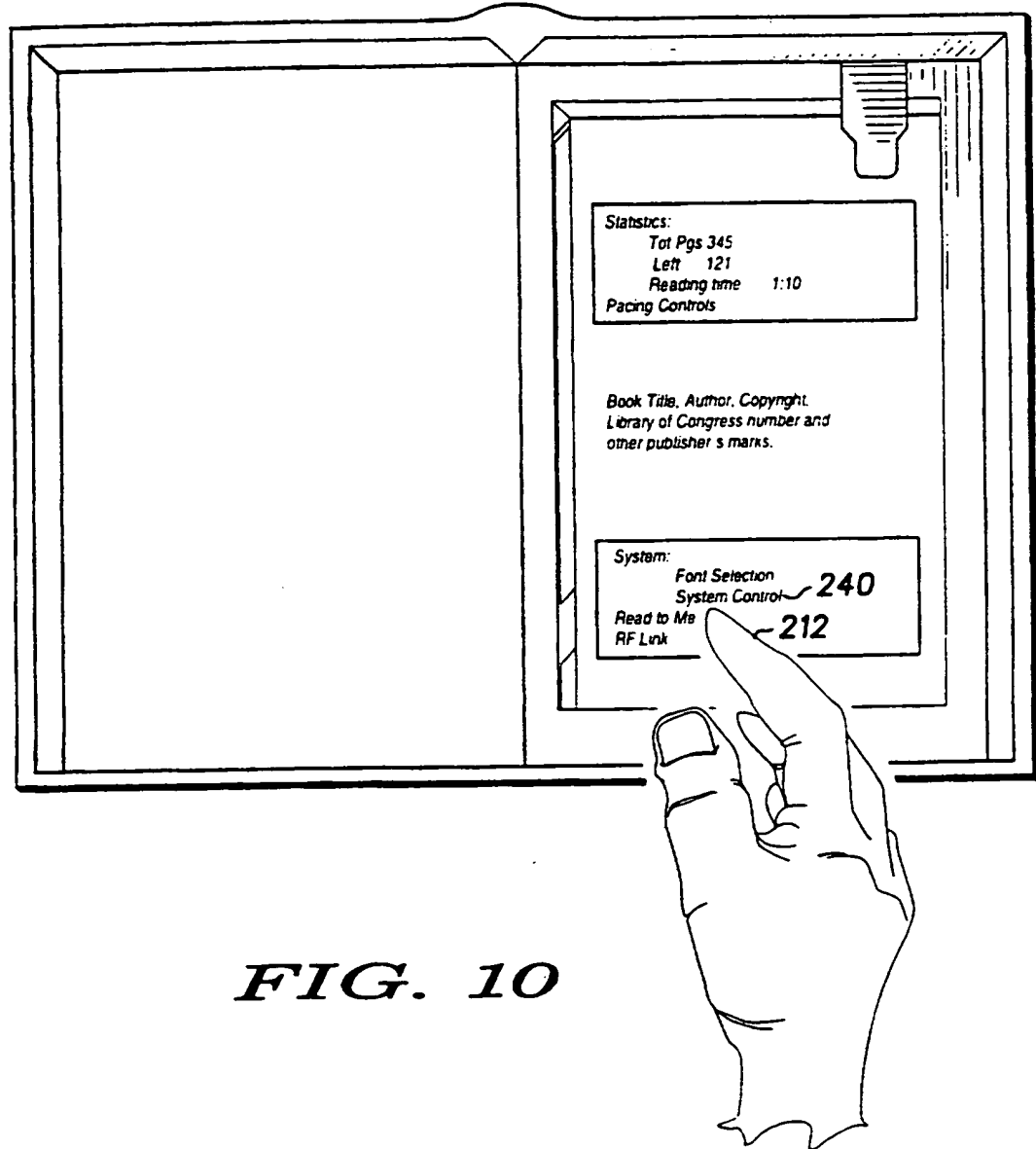

FIG. 10

10/29

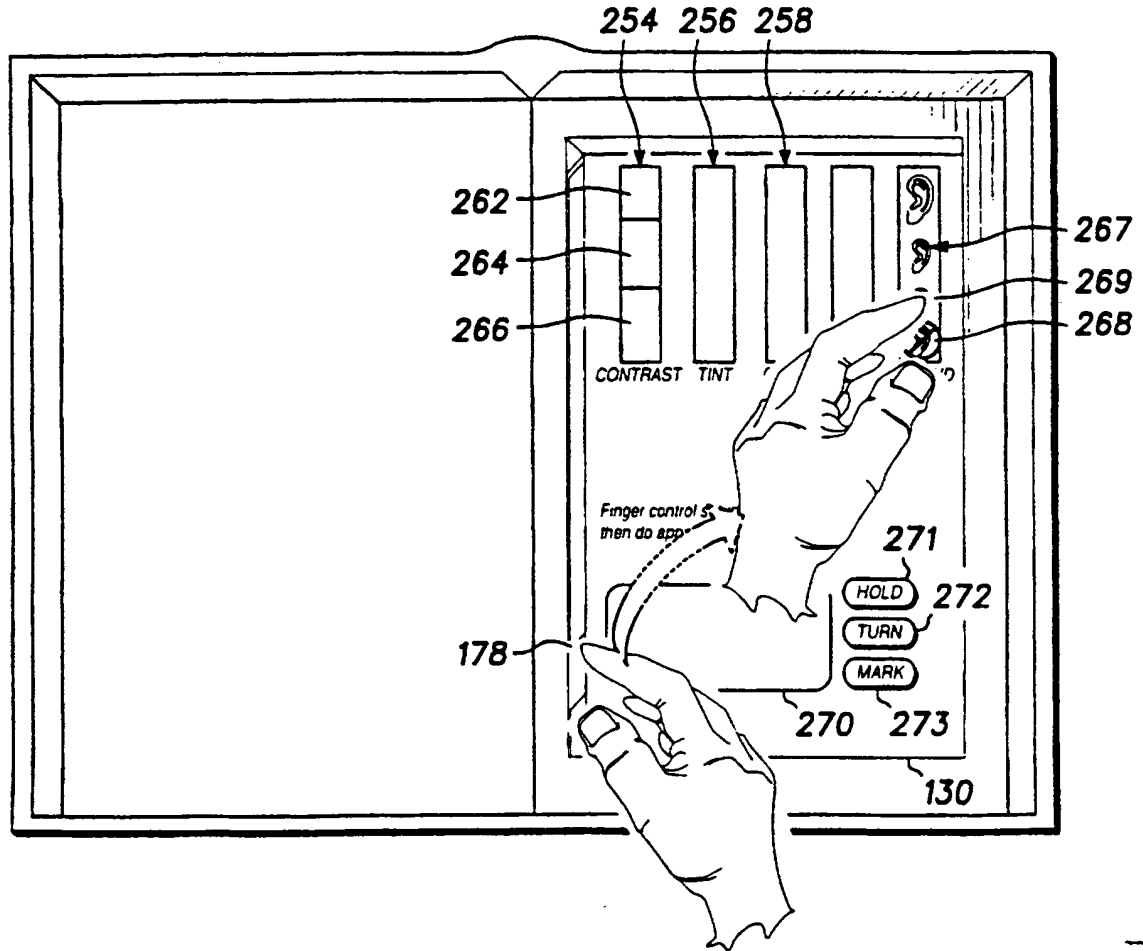

FIG. 11

11/29

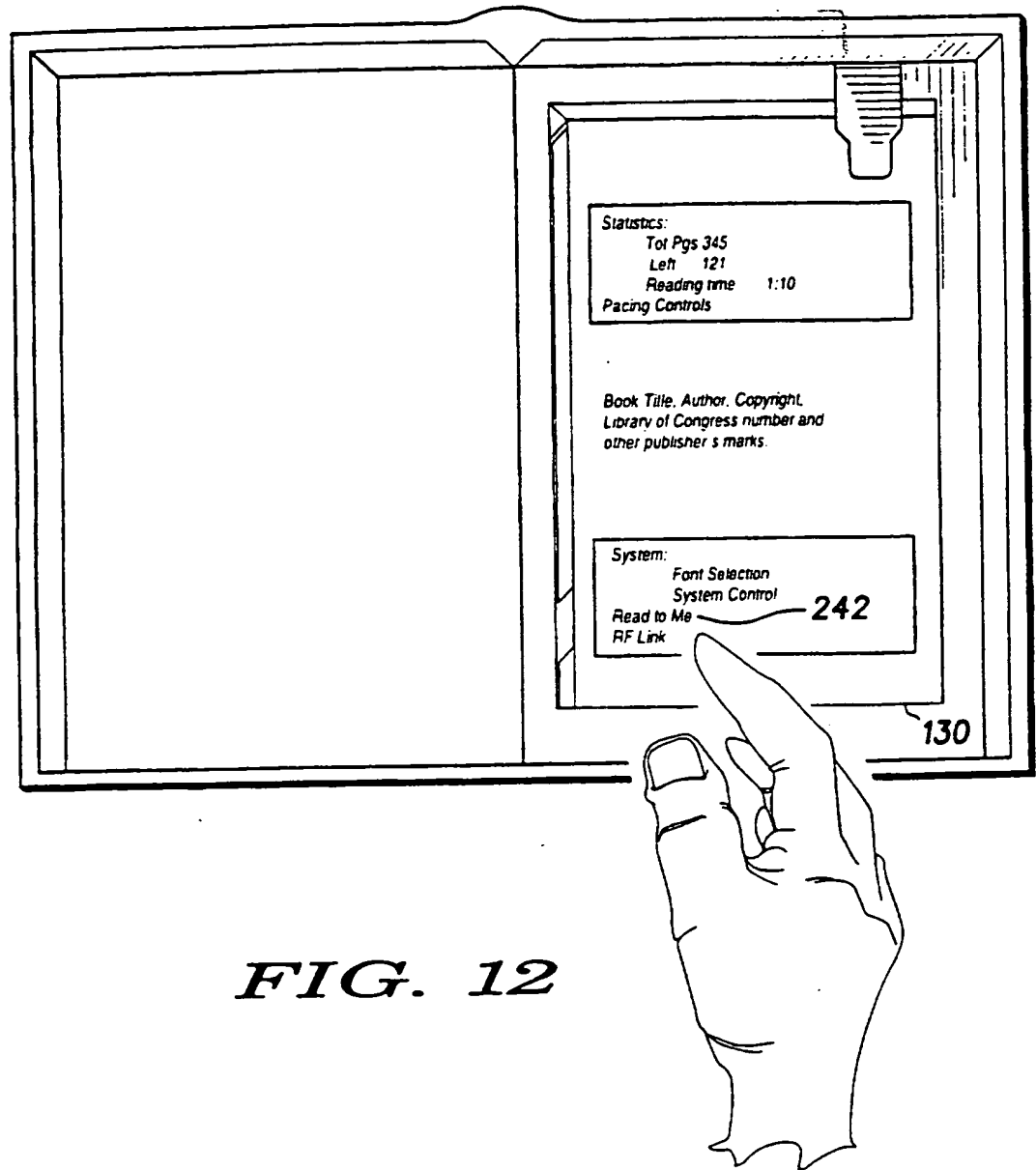
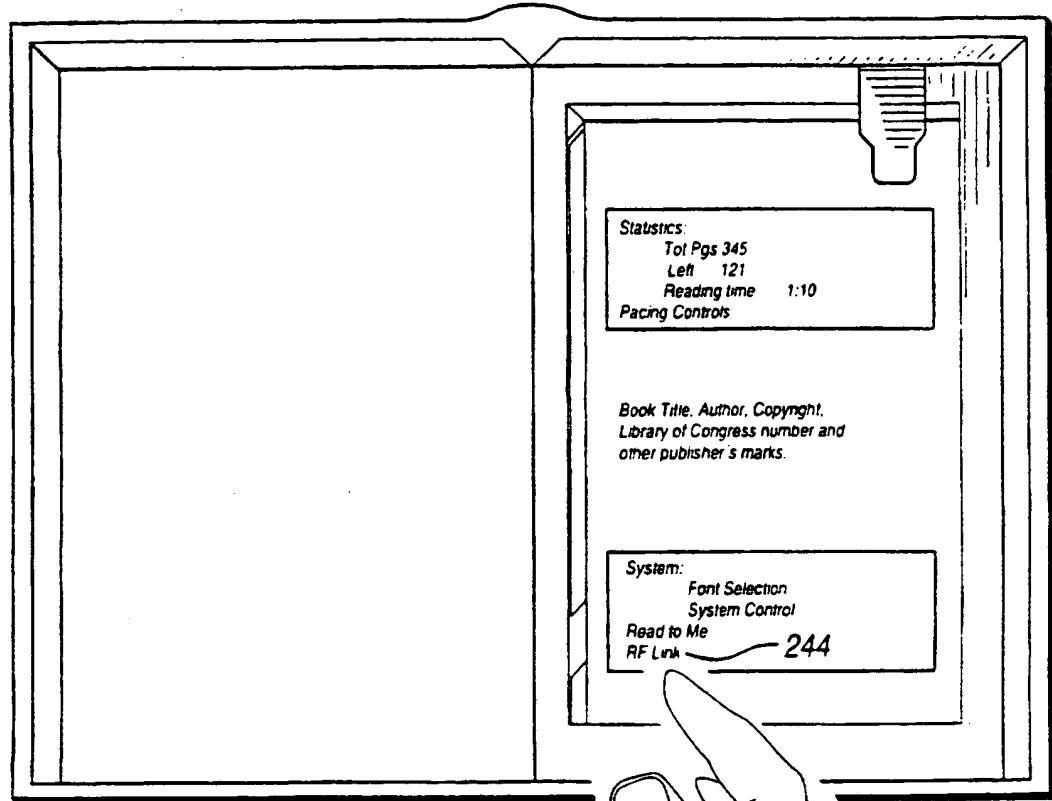

FIG. 12

12/29



212

FIG. 13

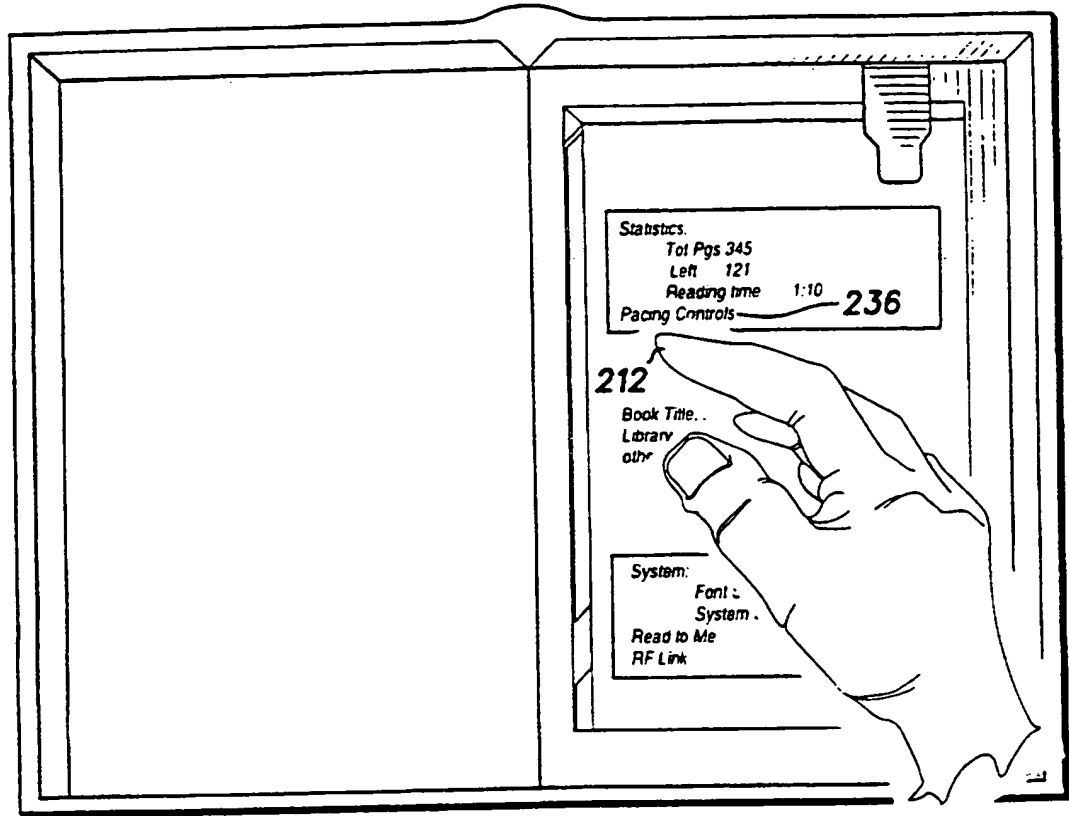

FIG. 14

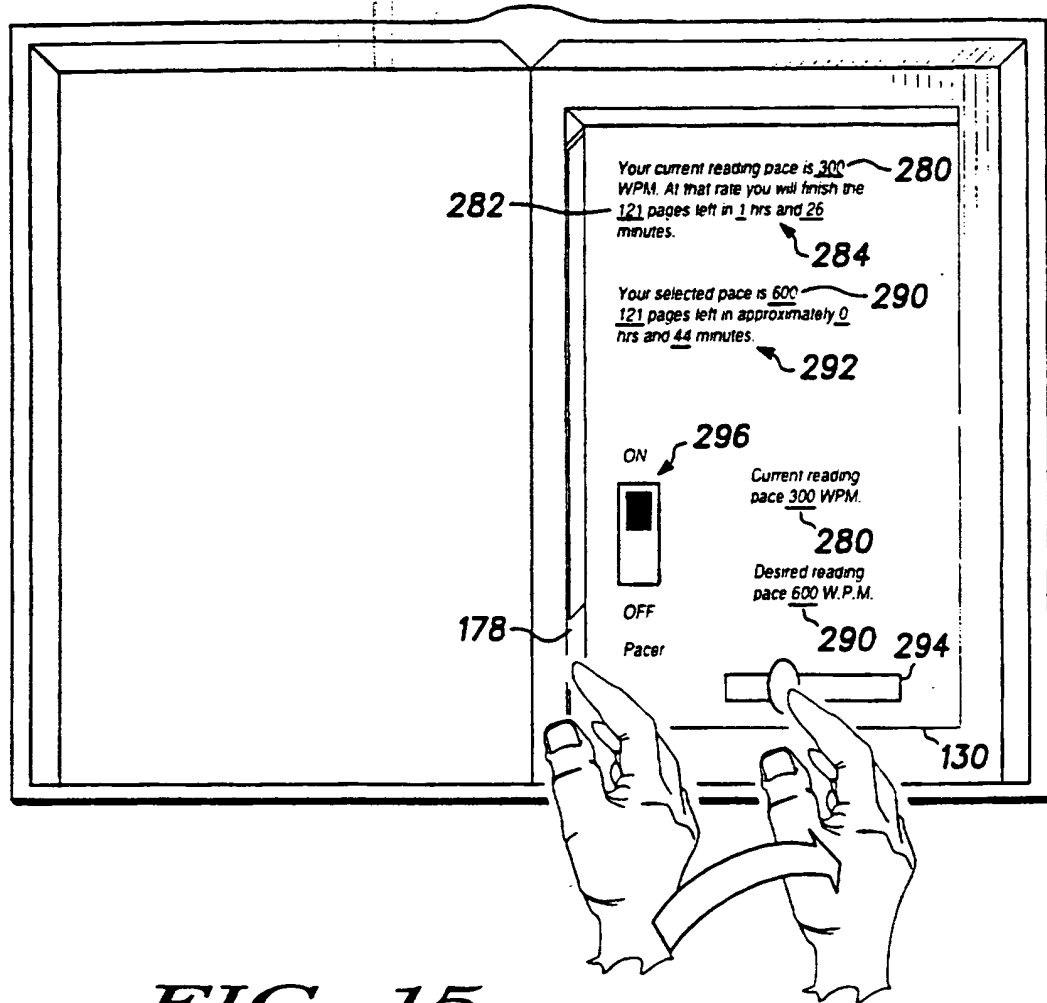

FIG. 15

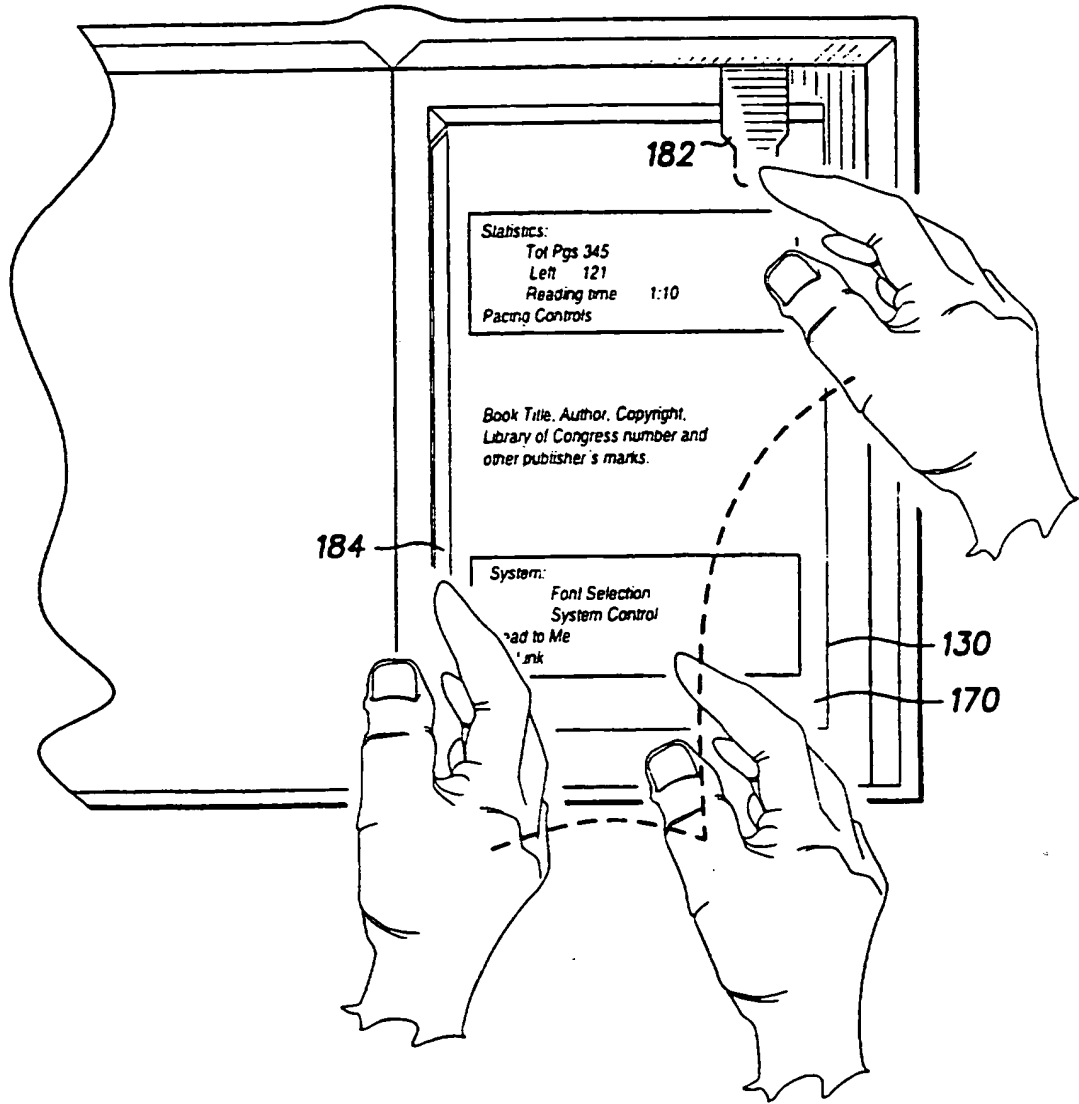

FIG. 16

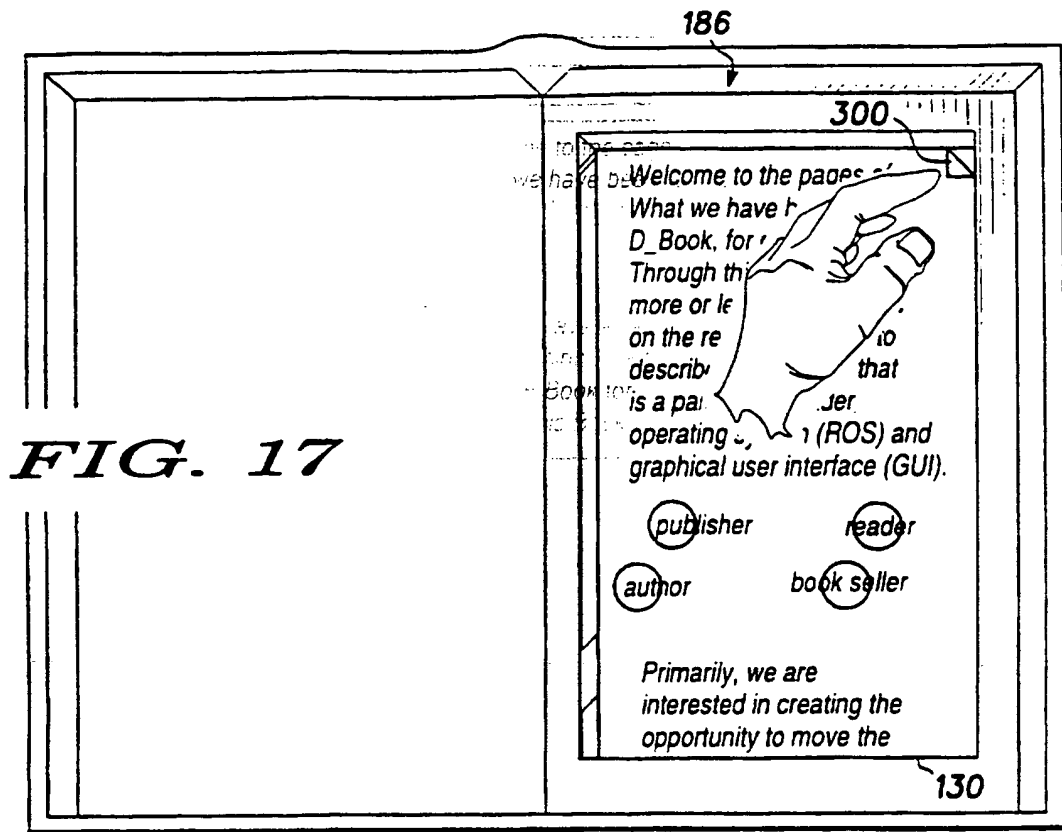

FIG. 17

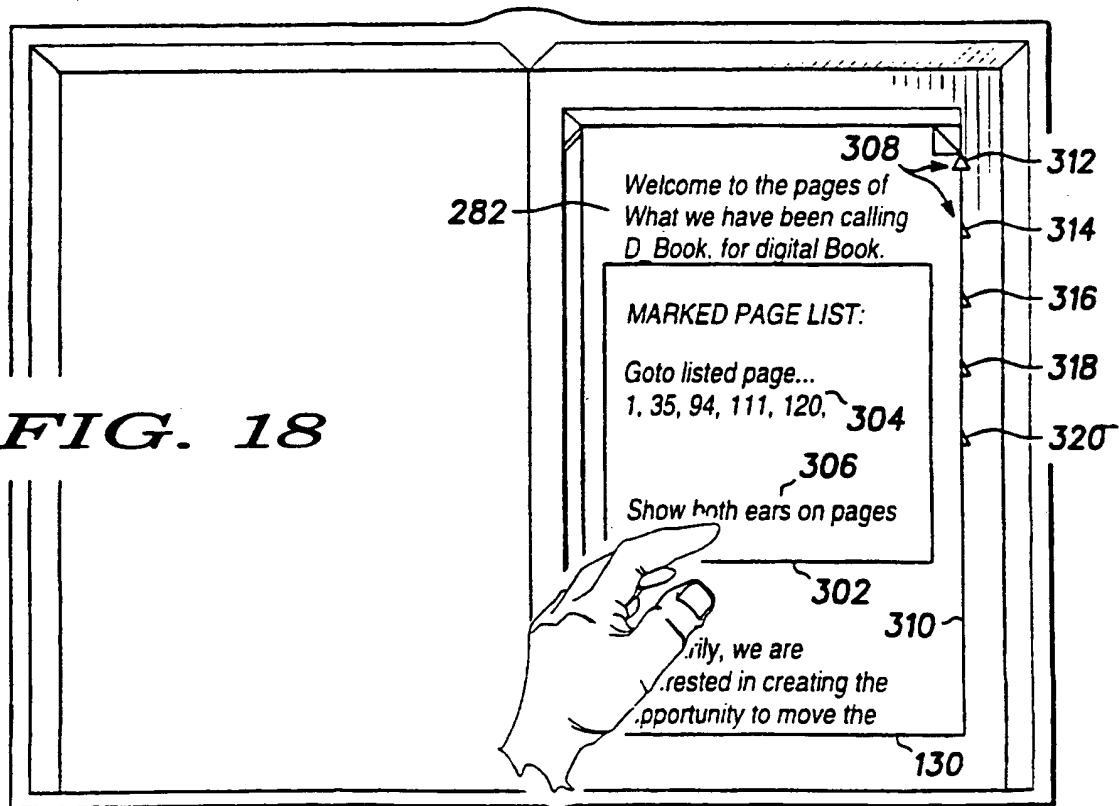
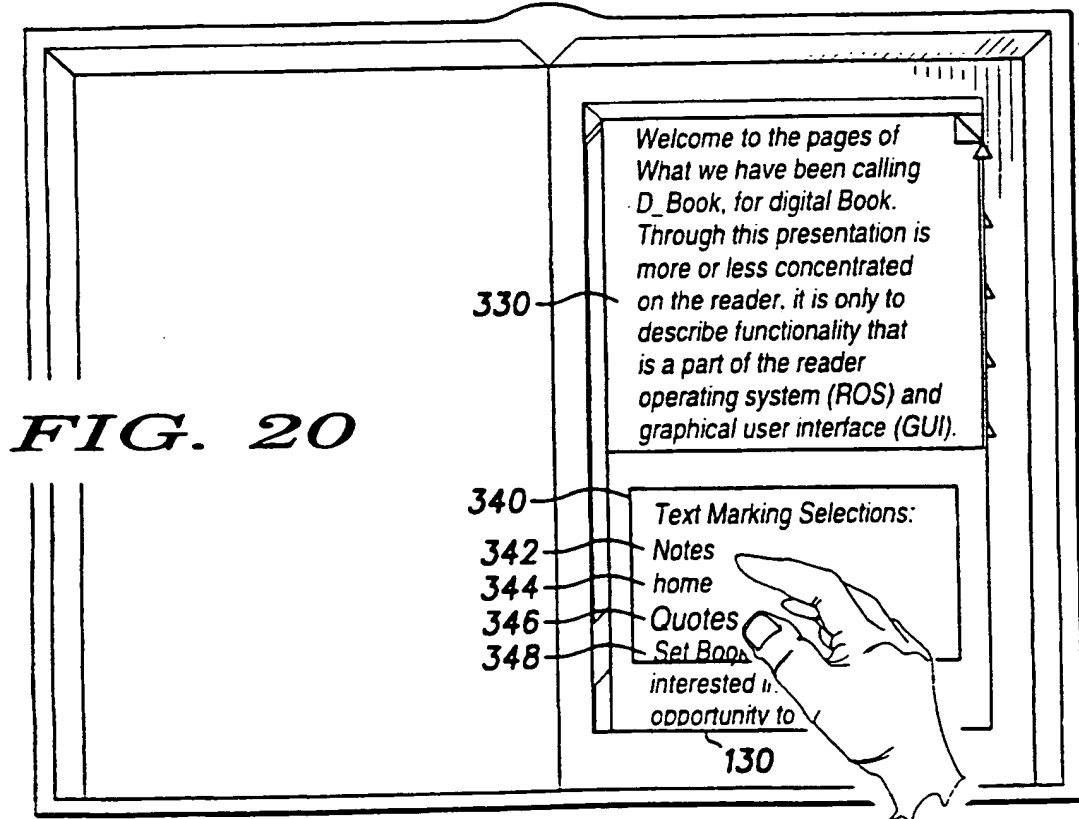
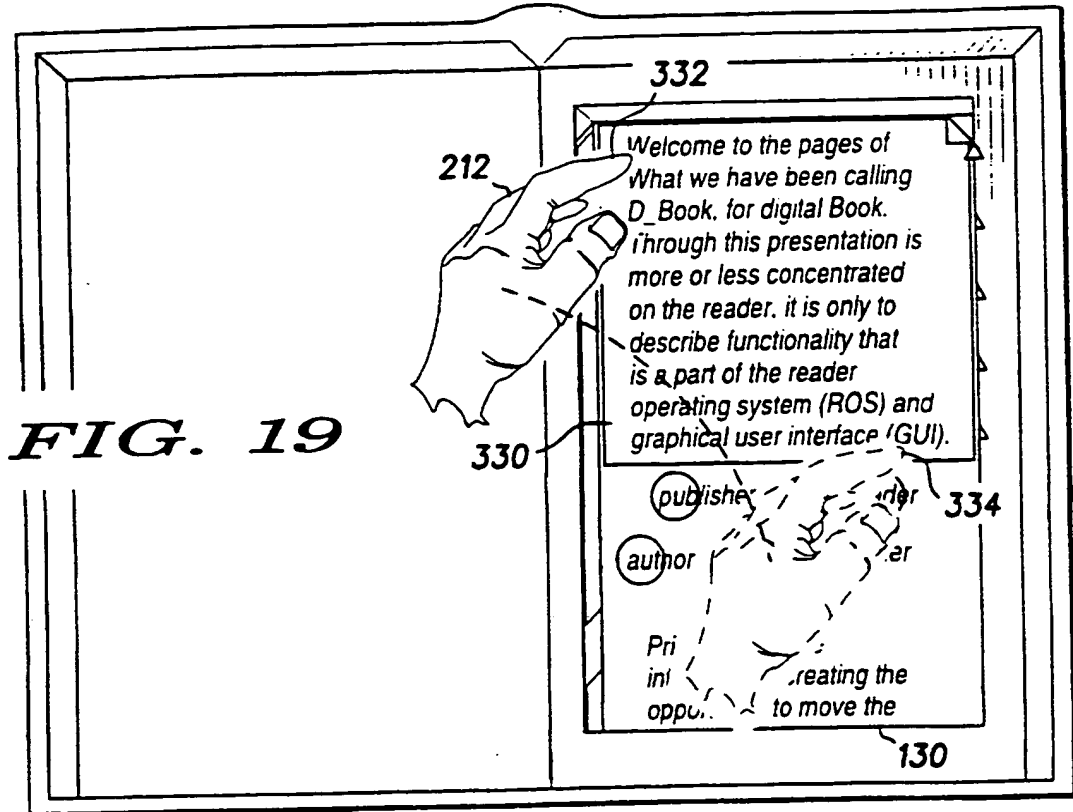

FIG. 18



18/29

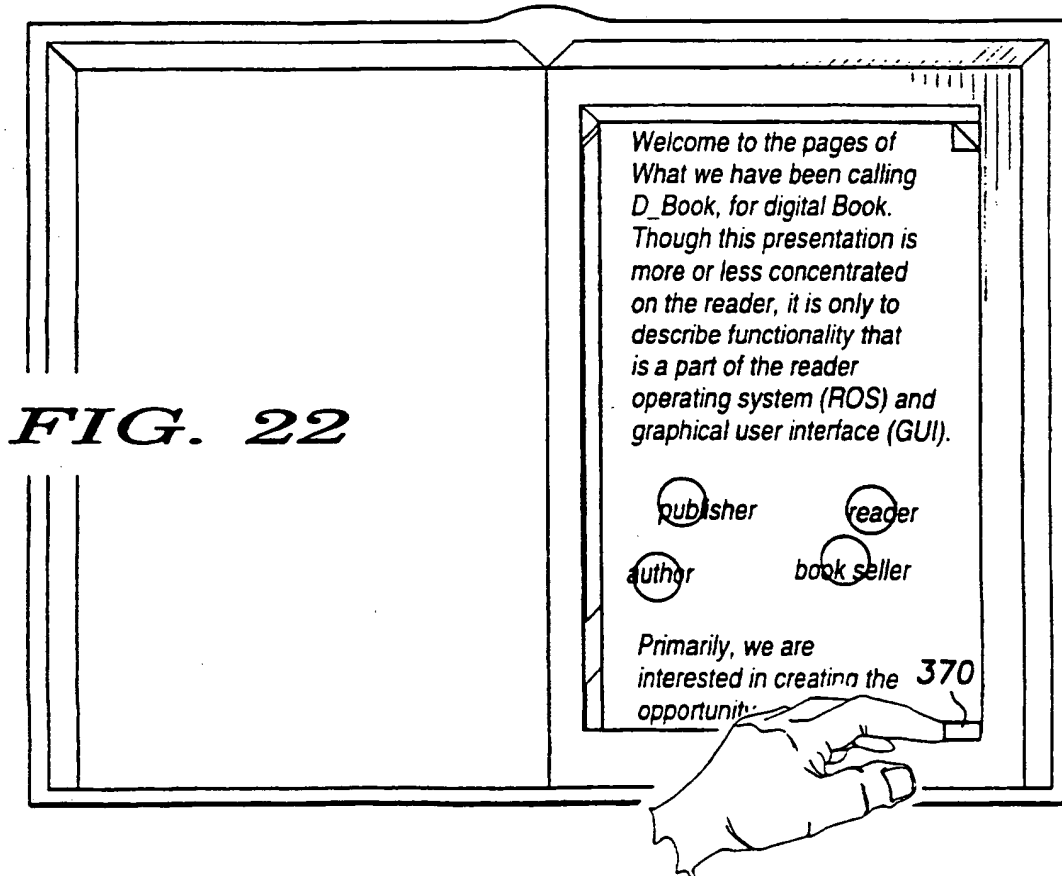
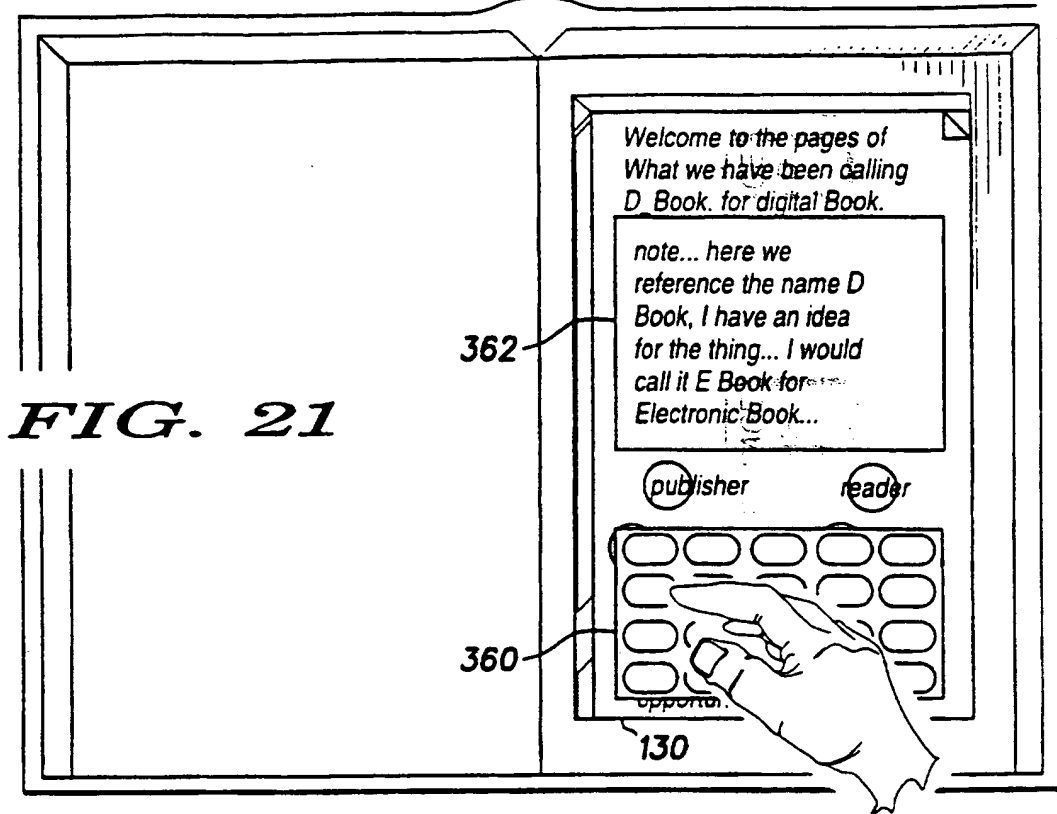

FIG. 23

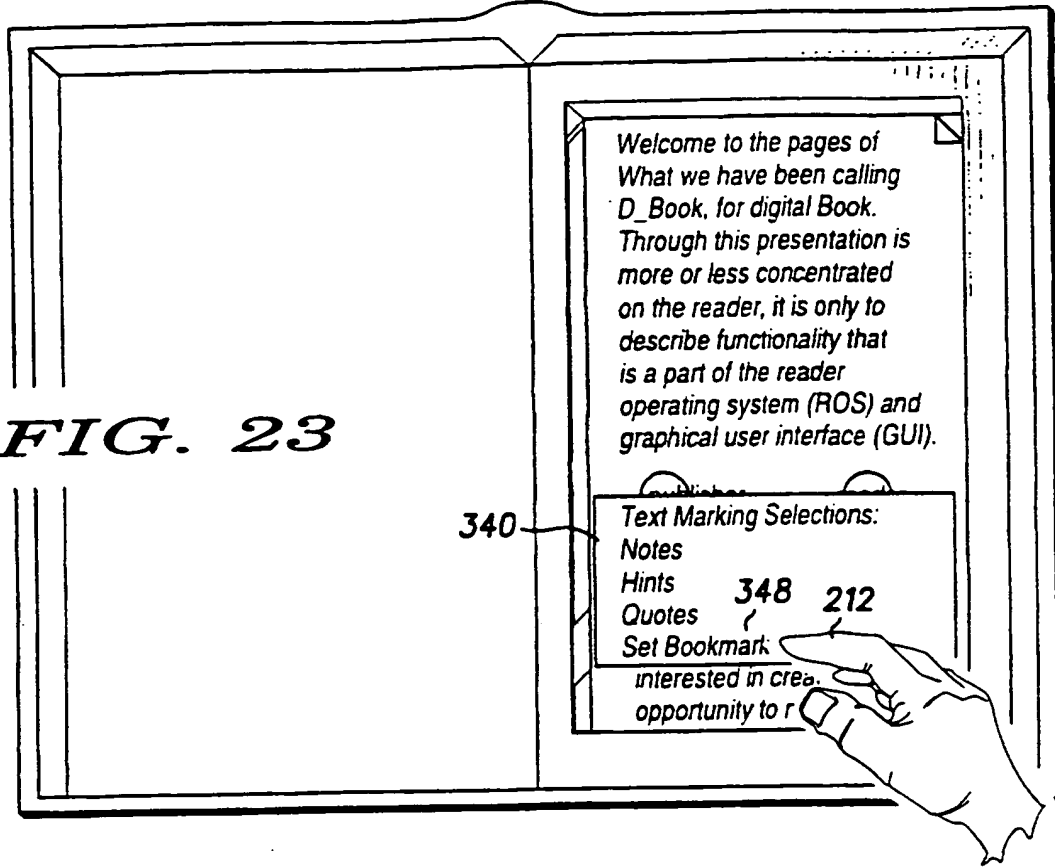
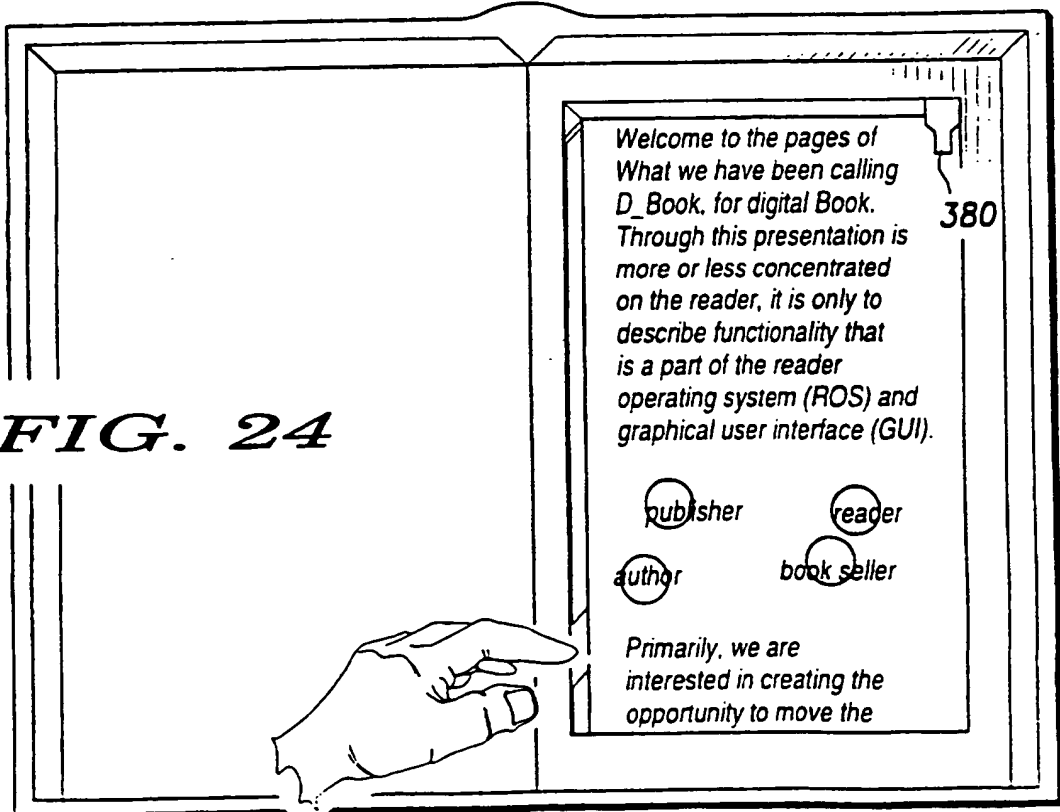

FIG. 24



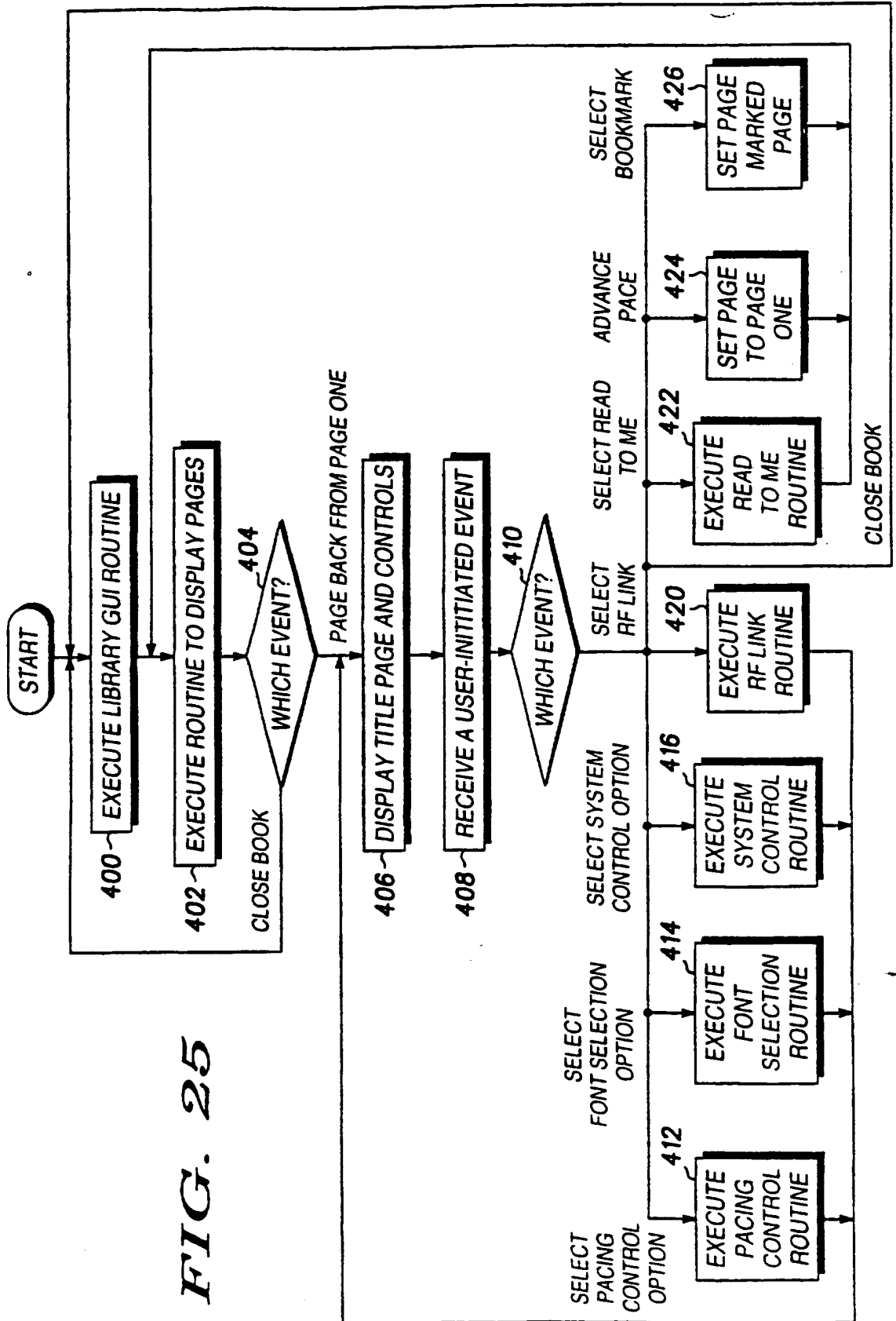
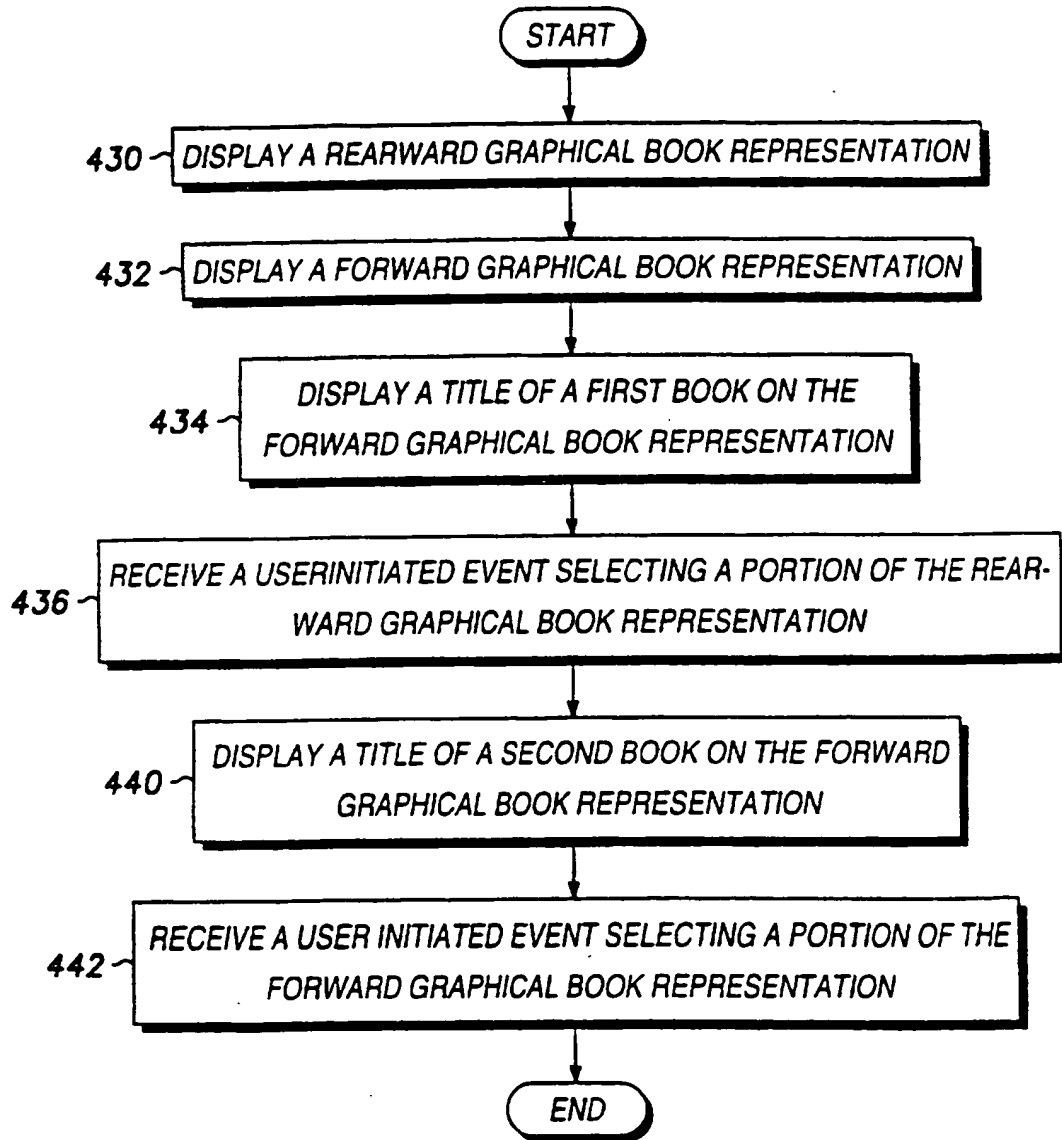

FIG. 25

21/29

**FIG. 26**

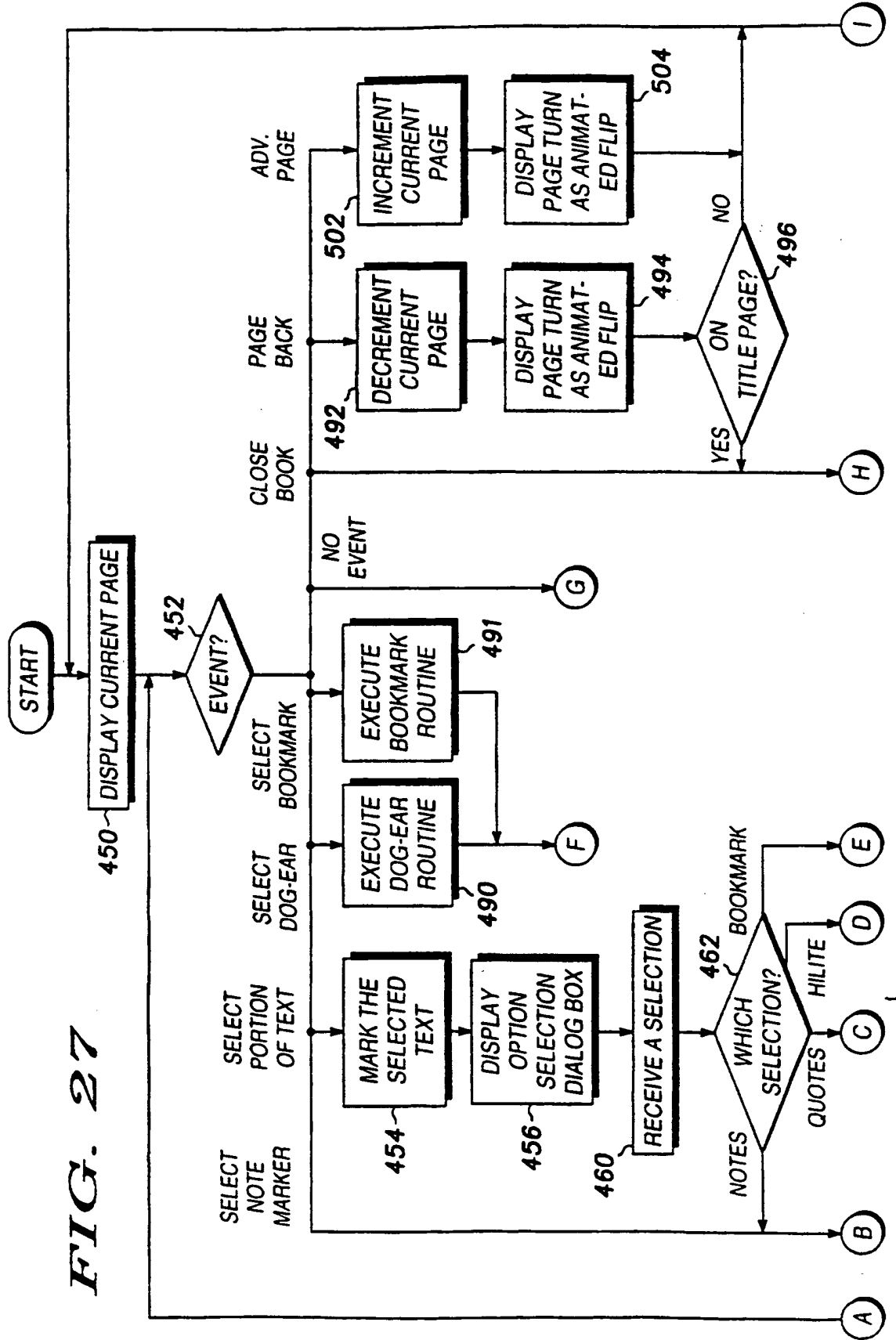

FIG. 27

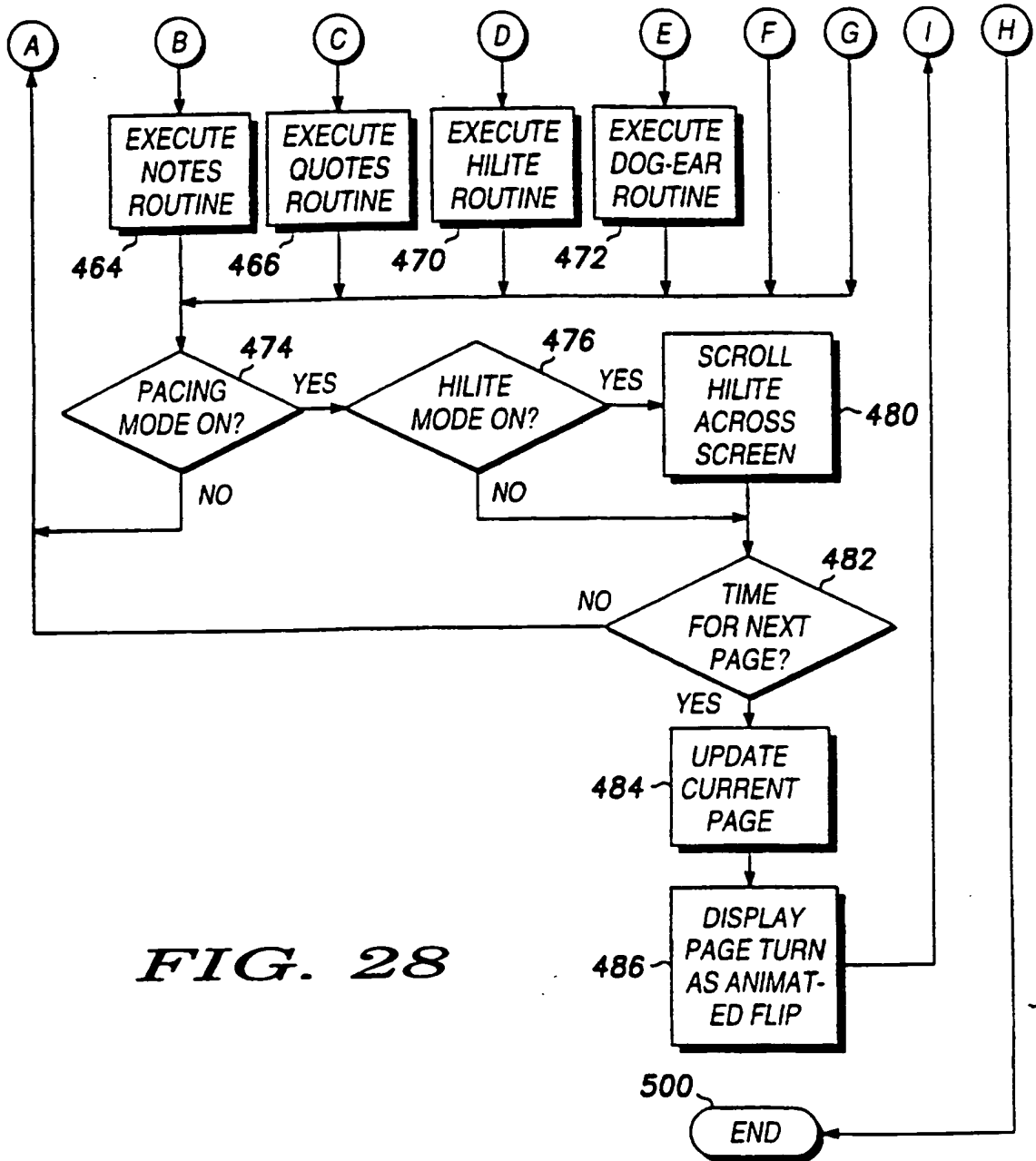

FIG. 28

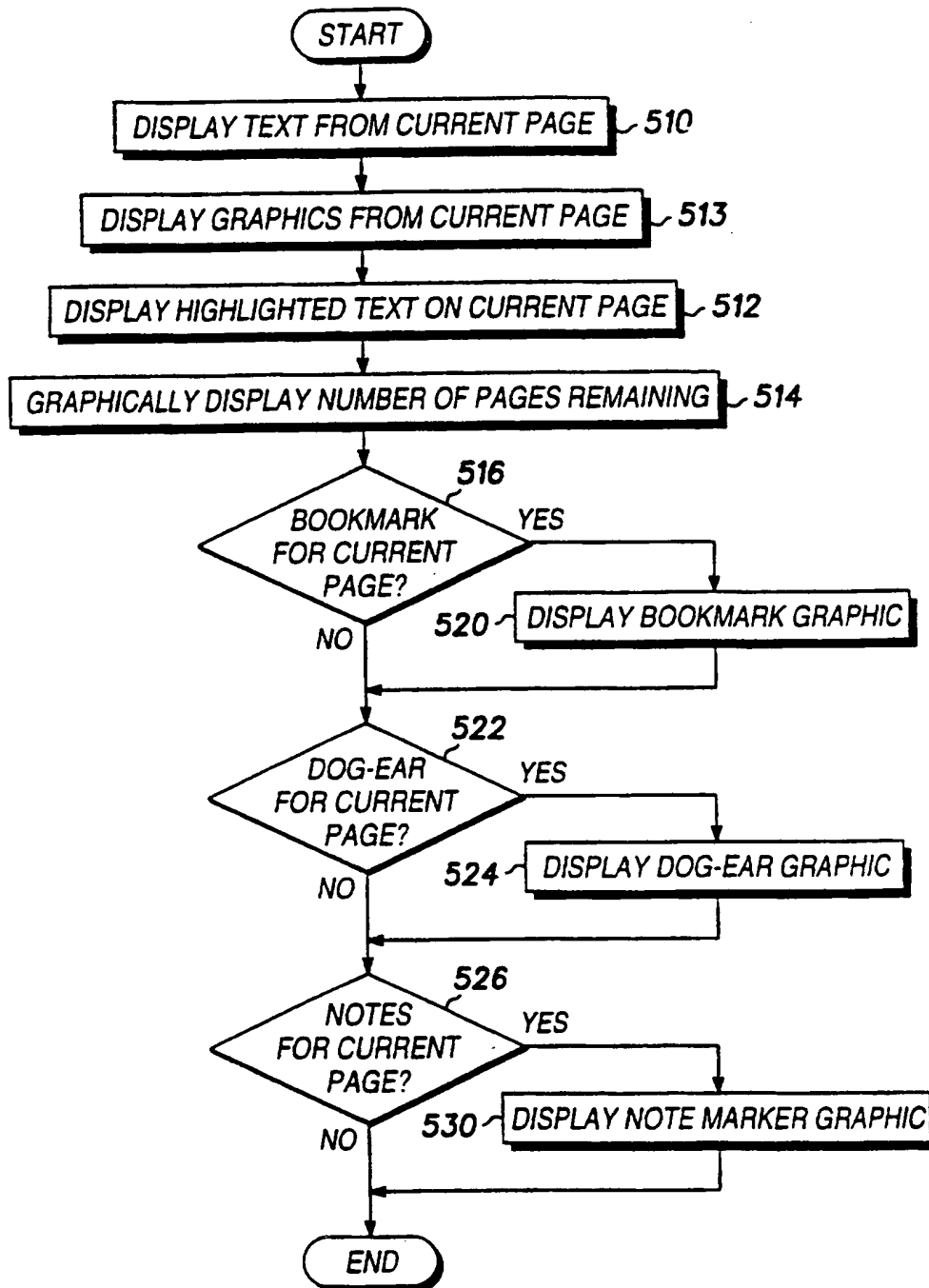

FIG. 29

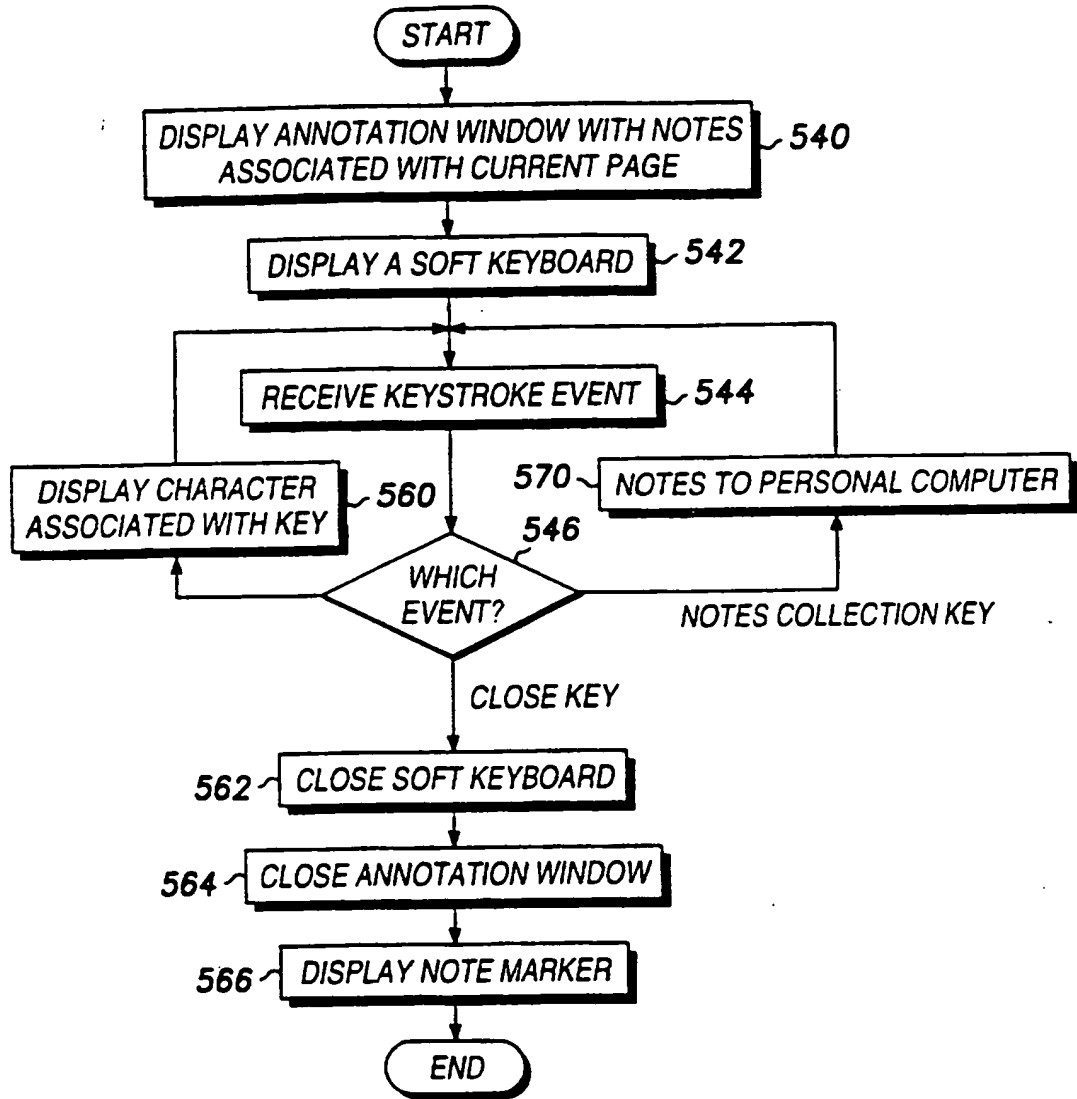

FIG. 30

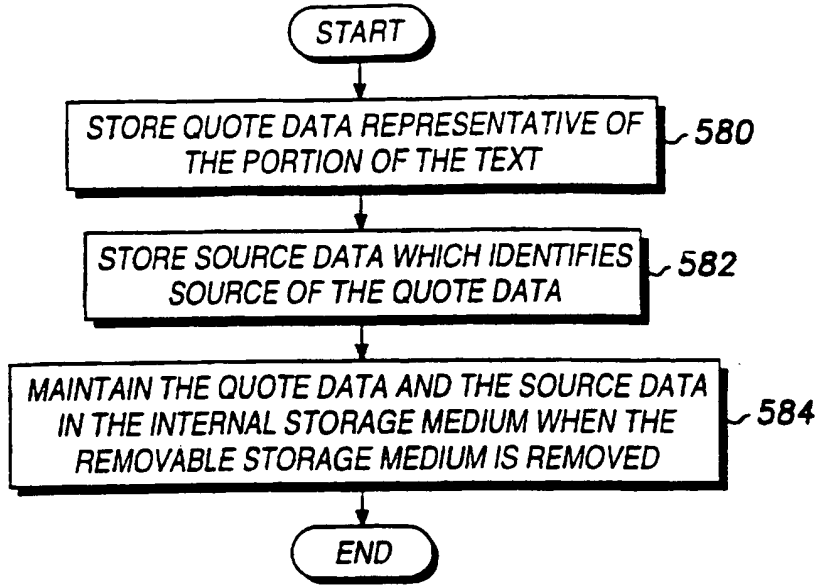

FIG. 31

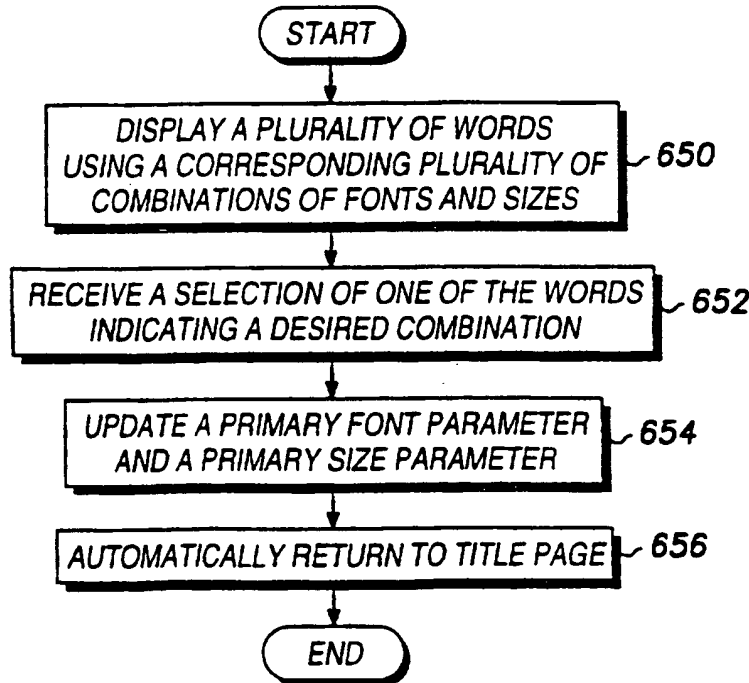

FIG. 34

27/29

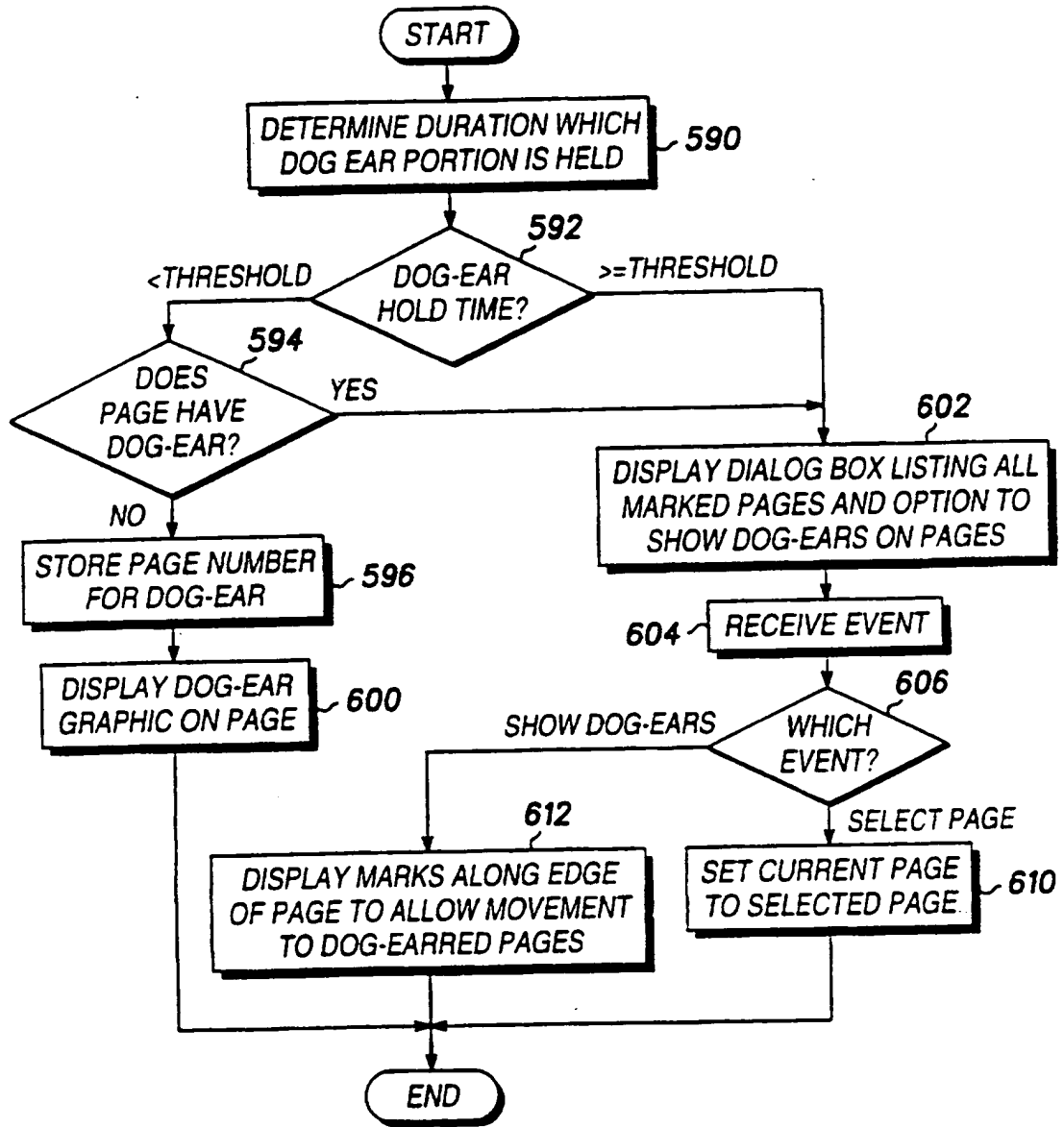

FIG. 32

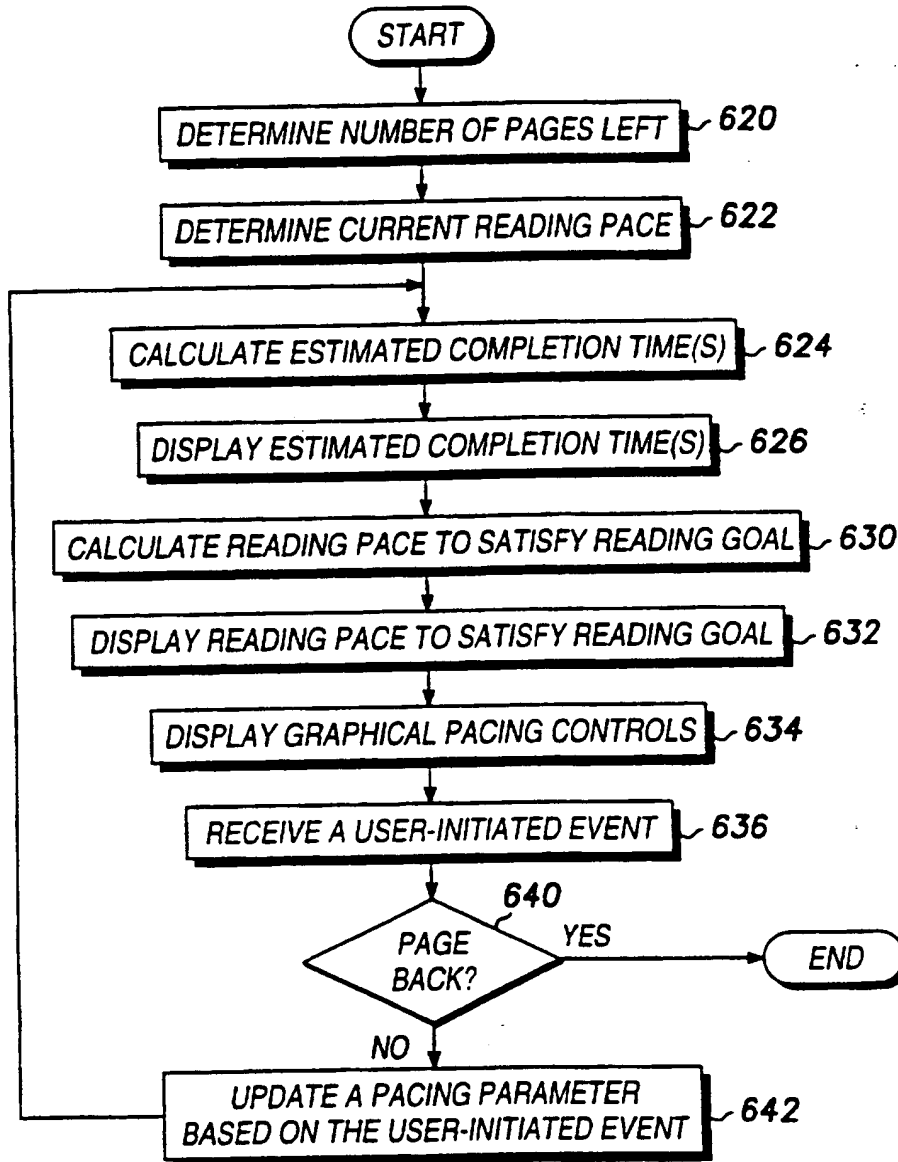

FIG. 33

29/29

FIG. 35

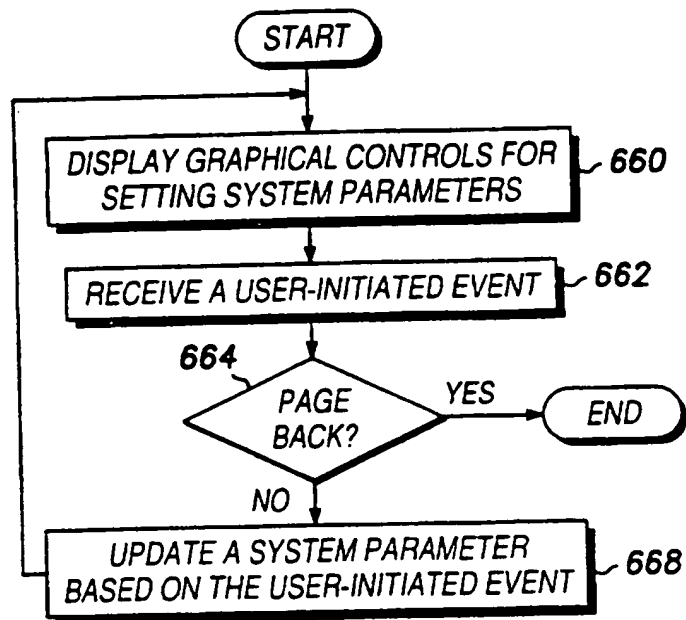

FIG. 35

INTERNATIONAL SEARCH REPORT

International application No.
PCT/US96/20451

A. CLASSIFICATION OF SUBJECT MATTER IPC(6) : G09G 5/00, 5/36; H01J 13/00; G09B 17/00, 5/00 US CL : 345/173, 133, 901; 395/353, 352; 434/178, 317 According to International Patent Classification (IPC) or to both national classification and IPC		
B. FIELDS SEARCHED Minimum documentation searched (classification system followed by classification symbols) U.S. : 345/173, 133, 146, 901; 434/178, 317 Documentation searched other than minimum documentation to the extent that such documents are included in the fields searched Electronic data base consulted during the international search (name of data base and, where practicable, search terms used)		
C. DOCUMENTS CONSIDERED TO BE RELEVANT		
Category*	Citation of document, with indication, where appropriate, of the relevant passages	Relevant to claim No.
Y	US 5,475,399 A (BORSUK) 12 December 1995, col.3, lines 43-56.	1-10
Y	US 5,060,135 A (LEVINE ET AL) 22 October 1991, columns 11-12.	1-10
A,P	US 5,534,888 A (LEBBY ET AL) 09 July 1996, columns 2-3.	1-10
<input type="checkbox"/> Further documents are listed in the continuation of Box C. <input type="checkbox"/> See patent family annex.		
* Special categories of cited documents:		*T later document published after the international filing date or priority date and not in conflict with the application but cited to understand the principle or theory underlying the invention
*A document defining the general state of the art which is not considered to be of particular relevance		*X document of particular relevance; the claimed invention cannot be considered novel or cannot be considered to involve an inventive step when the document is taken alone
*E earlier document published on or after the international filing date		*Y document of particular relevance; the claimed invention cannot be considered to involve an inventive step when the document is combined with one or more other such documents, such combination being obvious to a person skilled in the art
*L document which may throw doubts on priority claim(s) or which is cited to establish the publication date of another citation or other special reasons (as specified)		*A document member of the same patent family
*O document referring to an oral disclosure, use, exhibition or other means		
*P document published prior to the international filing date but later than the priority date claimed		
Date of the actual completion of the international search 18 MARCH 1997	Date of mailing of the international search report 23 APR 1997	
Name and mailing address of the ISA/US Commissioner of Patents and Trademarks Box PCT Washington, D.C. 20231 Facsimile No. (703) 305-3230	Authorized officer KENT CHANG <i>Jen Bell</i> Telephone No. (703) 305-4824	